

PRIME 6" LED ARCHITECTURAL ROUND FLANGED WALL WASH



USE OF PRODUCT

The 6" Prime Wall Wash Series Downlight is the ideal product for energy efficient lighting in commercial and residential applications where wall washing is required. Available in an assortment of color temperatures, optics, lumen outputs, and dimmable driver options.

LED ENGINE

LED engine available with CREE LEDs in 2700K, 3000K, 3500K, or 4000K in standard 93+ CRI. 2 Step MacAdam ellipse allows for color consistency between fixtures. LED mounted to aluminum heat sink for maximum life output and thermal management. Light engine provides a quick disconnect with locking strain relief to housing.

FRAME CONSTRUCTION

Constructed from 16 gauge heavy duty powder coated cold rolled steel frame with a large access junction box.

ADJUSTMENT

- Light engine locked at 25° tilt, consult factory for other tilt setting.
- Housing provides for 360° locking rotation
- Aperture collar adjusts 15°± horizontally within frame for square ceiling alignment.
- Collar notch allows for easy alignment for square applications.
- Aperture collar compatible up to 1½" ceiling thickness.
- Accommodation for 2" or 3" ceiling thickness available upon request.

OPTICS

Field replaceable optical lens available in 18°, 30°, 50°, and 80°. Easily achieve narrow spot to wide flood beam pattern. Option for frosted, honeycomb, or solite filter (2 Maximum).

DIMMING

Available in 7 driver selections. (ID) Standard all-inclusive ELV, Triac, and 0-10V dimming driver called Intelligent Drive, 120-277V. (PEQ0) Lutron Hi-Lume Premier Ecosystem 0.1% w/soft on, fade to black dimming, 120-277V. (LDE1) Lutron Hi-Lume 1% Ecosystem with soft on, fade to black dimming, 120-277V. (L3DA) Hi-lume 1% EcoSystem/3-Wire L3D Driver. (EEI) eldoLED Eco 1% Dim (0-10V), 120-277V. (EDIO) eldoLED Solo 0.1% Dim(0-10V), 120-277V. (EDID) eldoLED Solo 0.1% Dim(DALI), 120-277V.

THERMAL MANAGEMENT

Ambient temperatures at fixture location should not exceed -20° to 40°C.

EMERGENCY BATTERY

Optional emergency battery available for a minimum of 90 minutes with both integral or remote test switch in 800 or 1700 delivered lumens.

TRIM OPTIONS

- All trims are self flanged die cast or anodized.
- Trim includes standard frosted acrylic diffuser.
- 12% lumens increase if remove standard frosted acrylic diffuser in field.
- Optical Enhancer reflects light evenly across the diffusion lens.
- Trims available in round or square in an assortment of standard or made to order finishes.

LABELS/COMPLIANCE/WARRANTY

- CSA Listed for US and Canada
- Energy Star
- Dry/Damp/Wet location rated.
- Title 24, JA8 Compliant
- 5 Year limited warranty



ORDERING INFORMATION

RPA

Series	Aperture size	Lumens	Color Temperature	Voltage	Dimming	Optical Lens	Filter
RPA PRIME Series	6 - 6"	8L ¹ - 835 lm	27 - 2700K	UNV - 120-277	ID ³ Standard all-inclusive ELV, Triac, and 0-10V dimming driver (Intelligent Drive)	18 - 18°	None - Leave blank
		9L ¹ - 940 lm	30 - 3000K	120 - 120V	PEQ0 ⁴ Lutron Hi-Lume Premier Ecosystem 0.1% w/soft on, fade to black dimming	30 - 30°	F - Frosted filter
		12L ¹ - 1270 lm	35 - 3500K	347 ² - 347V	LDE1 ⁵ Lutron Hi-Lume 1% Ecosystem with soft on, fade to black dimming	50 - 50°	H - Honey comb
		16L ¹ - 1685 lm	40 - 4000K		L3DA Hi-lume 1% EcoSystem/3-Wire L3D Driver	80 - 80°	S - Solite filter
		19L ¹ - 1975 lm			EEI ^{6,7,8} eldoLED Eco 1% Dim (0-10V)		
		24L ¹ - 2460 lm			EDIO ^{6,7,8} eldoLED Solo 0.1% Dim (0-10V)		
		27L - 2795 lm			EDID ^{6,7,8} eldoLED Solo 0.1% Dim (DALI)		
30L - 3025 lm							

Housing Type	Aperture	Frame Accessories	Collar	Options
NC - Non-IC New Construction IC ¹⁰ - Air-tight New Construction	RFW - Round Flanged Wall Wash	UH ¹ - Universal bar hanger C - C-Channel bar hanger B - Flat bar hanger WJ ¹¹ - Wood Joist	Blank - 1.5" Depth 20 - 2" Depth 30 - 3" Depth MTO - Made to order	EI8 - Emergency battery with integral switch(800 Lumens) ER8 - Emergency battery with remote switch (800 Lumens) EI17 - Emergency battery with integral switch(1700 Lumens) ER17 - Emergency battery with remote switch (1700 Lumens) FCJS-E - VIVE wireless individual controller(Ecosystem) FCJS-0 - VIVE wireless individual controller(0-10) LAW - Lutron Athena Wireless Node (RF only version) CP10 ¹² - Chicago Plenum

TRIM ORDERING INFORMATION

Aperture Size / Shape / Trim Type / Style	Bevel / Flange Finish	Options
6RFA - 6" Round Flange Accent	W-W - White bevel / white flange H-W - Haze bevel / white flange B-B - Black bevel / black flange H-H - Haze bevel / Haze flange S-S - Specular clear bevel / Specular clear flange S-W - Specular clear bevel / white flange WE-WE - Wheat bevel / wheat flange MTO - Made to order	WL - Wet Location

1. Compatible with IC new construction housing.
2. Step down transformer required.
3. Intelligent Drive is the standard driver.
4. Driver must not exceed 1255 lm
5. 120V only.
6. Inapplicable to 3025 Lumen offering.
7. Must specify logarithmic or linear eldoLED driver.
8. Confirm dimming curve: linear or logarithmic.
9. Without standard frosted acrylic diffuser.
10. Compatible up to 2460 lumens.
11. Wood joist only available in round.
12. Requires IC Housing

PRIME 6" LED ARCHITECTURAL ROUND FLANGED DOWNLIGHT



USE OF PRODUCT

The 6" Prime Downlight Series is the ideal product for architectural energy efficient lighting in commercial and residential applications. Available in an assortment of color temperatures, optics, lumen outputs, and dimmable driver options.

LED ENGINE

LED engine available with CREE LEDs in 2700K, 3000K, 3500K, or 4000K in standard 93+ CRI. 2 Step MacAdam ellipse allows for color consistency between fixtures. LED mounted to aluminum heat sink for maximum life output and thermal management. Light engine provides a quick disconnect with locking strain relief to housing.

FRAME CONSTRUCTION

Constructed from 16 gauge heavy duty powder coated cold rolled steel frame with a large access junction box.

ADJUSTMENT

- Housing provides for 360° locking rotation
- Aperture collar adjusts 15°± horizontally within frame for square ceiling alignment
- Collar notch allows for easy alignment for square applications.

- Aperture collar compatible up to 1½" ceiling thickness.
- Accommodation for 2" or 3" ceiling thickness available upon request.

OPTICS

Field replaceable optical lens available in 18°, 30°, 50°, and 80°. Easily achieve narrow spot to wide flood beam pattern. Option for frosted, honeycomb, or solite filter (2 maximum).

DIMMING

Available in 7 driver selections. (ID) Standard all-inclusive ELV, Triac, and 0-10V dimming driver called Intelligent Drive, 120-277V. (PEQ0) Lutron Hi-Lume Premier Ecosystem 0.1% w/soft on, fade to black dimming, 120-277V. (LDE1) Lutron Hi-Lume 1% Ecosystem with soft on, fade to black dimming, 120-277V. (L3DA) Hi-lume 1% EcoSystem/3-Wire L3D Driver (EEI) eldoLED Eco 1% Dim (0-10V), 120-277V. (EDIO) eldoLED Solo 0.1% Dim(0-10V), 120-277V. (EDID) eldoLED Solo 0.1% Dim(DALI), 120-277V.

THERMAL MANAGEMENT

Ambient temperatures at fixture location should not exceed -20° to 40°C.

EMERGENCY BATTERY

Optional emergency battery available for a minimum of 90 minutes with both integral or remote test switch in 800 or 1700 delivered lumens.

TRIM OPTIONS

- All trims are self flanged die cast or anodized.
- Trim includes standard frosted acrylic diffuser.
- 12% lumens increase if remove standard frosted acrylic diffuser in field.
- Optical Enhancer reflects light evenly across the diffusion lens.
- Trims available in round or square in an assortment of standard or made to order finishes.

LABELS/COMPLIANCE/WARRANTY

- CSA Listed for US and Canada
- Energy Star
- Dry/Damp/Wet location rated.
- Title 24 compliance
- JAB Certified
- 5 year limited warranty.



ORDERING INFORMATION

RPA

Series	Aperture size	Lumens	Color Temperature	Voltage	Dimming	Optical Lens ³	Filter
RPA	6 - 6"	10L ¹ - 1060 lm	27 - 2700K	UNV - 120-277	ID ³ Standard all-inclusive ELV, Triac, and 0-10V dimming driver (Intelligent Drive)	18 - 18°	None - Leave blank
PRIME Series		13L ¹ - 1320 lm	30 - 3000K	120 - 120V	PEQ0 ⁴ Lutron Hi-Lume Premier Ecosystem 0.1% w/soft on, fade to black dimming	30 - 30°	F - Frosted filter
		16L ¹ - 1650 lm	35 - 3500K	347 ² - 347V	LDE1 ⁵ Lutron Hi-Lume 1% Ecosystem with soft on, fade to black dimming	50 - 50°	H - Honey comb
		21L ¹ - 2185 lm	40 - 4000K		L3DA	80 - 80°	S - Solite filter
		25L ¹ - 2550 lm			EEI ^{6,7,8} Hi-lume 1% EcoSystem/3-Wire L3D Driver		
		31L - 3175 lm			EDIO ^{6,7,8} eldoLED Eco 1% Dim (0-10V)		
		35L - 3560 lm			EDID ^{6,7,8} eldoLED Solo 0.1% Dim (0-10V)		
		41L - 4155 lm			elidoLED Solo 0.1% Dim (DALI)		

Housing Type	Aperture	Frame Accessories	Collar	Options
NC - Non-IC New Construction	RFD - Round Flanged Downlight	UH ¹ - Universal bar hanger	Blank - 1.5" Depth	EI8 - Emergency battery with integral switch(800 Lumens)
IC ¹⁰ - Air-tight New Construction		C - C-Channel bar hanger	20 - 2" Depth	ER8 - Emergency battery with remote switch (800 Lumens)
		B - Flat bar hanger	30 - 3" Depth	EI17 - Emergency battery with integral switch(1700 Lumens)
		WJ ¹¹ - Wood Joist	MTO - Made to order	ER17 - Emergency battery with remote switch (1700 Lumens)
				FCJS-E - Vive wireless individual controller(Ecosystem)
				FCJS-0 - Vive wireless individual controller(0-10)
				LAW - Lutron Athena Wireless Node (RF only version)
				CP ^{10,12} - Chicago Plenum

TRIM ORDERING INFORMATION

Aperture Size / Shape / Trim Type / Style	Bevel / Flange Finish	Options
6RFO - 6" Round Flange Open	W-W - White bevel / white flange H-W - Haze bevel / white flange B-B - Black bevel / black flange H-H - Haze bevel / Haze flange S-S - Specular clear bevel / Specular clear flange S-W - Specular clear bevel / white flange WE-WE - Wheat bevel / wheat flange MTO - Made to order	WL - Wet Location

- Compatible with IC new construction housing.
- Step down transformer required.
- Intelligent Drive is the standard driver.
- Driver must not exceed 1650 lm
- 120V only.
- Inapplicable to 4155 Lumen offering.
- Must specify logarithmic or linear eldoLED diver.
- Confirm dimming curve: linear or logarithmic.
- Without standard frosted acrylic diffuser.
- Compatible up to 2550 lumens.
- Wood joist only available in round.
- Requires IC Housing

LUMEN CHART

Wattage	Delivered Lumens	Voltage	CRI
11W	1060 lm	120 - 277V	93+
16W	1320 lm	120 - 277V	93+
20W	1650 lm	120 - 277V	93+
30W	2185 lm	120 - 277V	93+
31W	2550 lm	120 - 277V	93+
38W	3175 lm	120 - 277V	93+
45W	3560 lm	120 - 277V	93+
58W	4155 lm	120 - 277V	93+

MULTIPLIERS

Color Temperature	Lumen Multiplier
2700K	0.93
3000K	1.00
3500K	1.07
4000K	1.15

*Above chart, ordering information, and IES File name reflect delivered lumens based 3000K and 30° optical lens.
 **Lumens will vary based on CCT, optical lens, and bevel finish.

TRIM DIMENSION

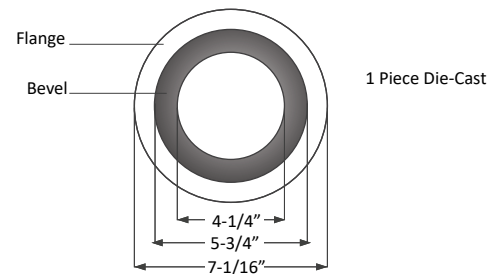
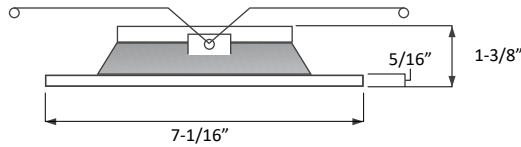

LED HOLDER & FILTER DIMENSION

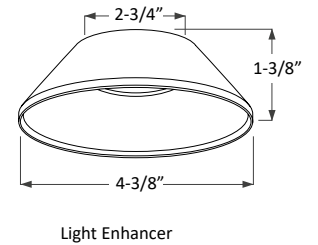
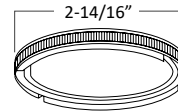
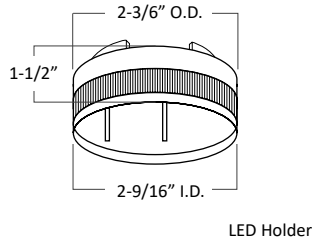
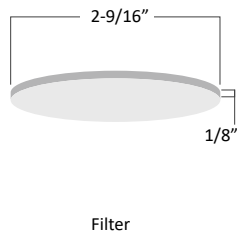

HOUSING DIMENSION



NC - Non-IC New Construction

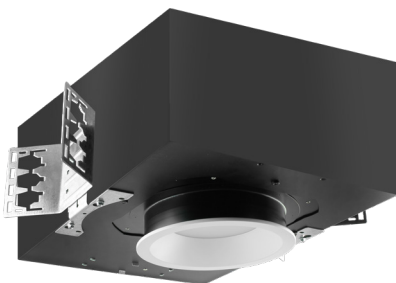
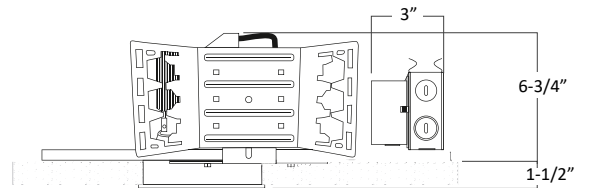
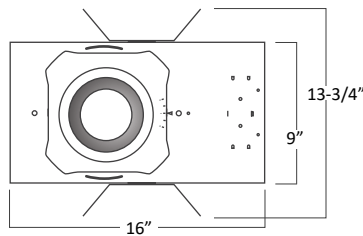

IC - Air-tight New Construction

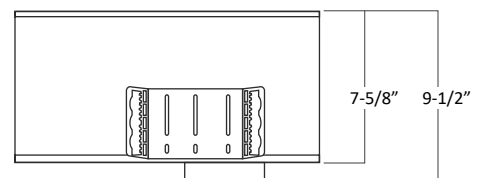
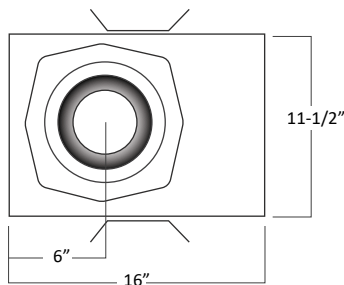

COLLAR DEPTH PER CEILING THICKNESS

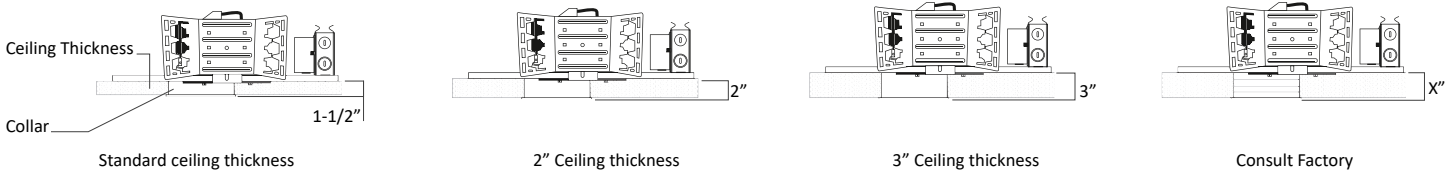

FRAME ACCESSORIES

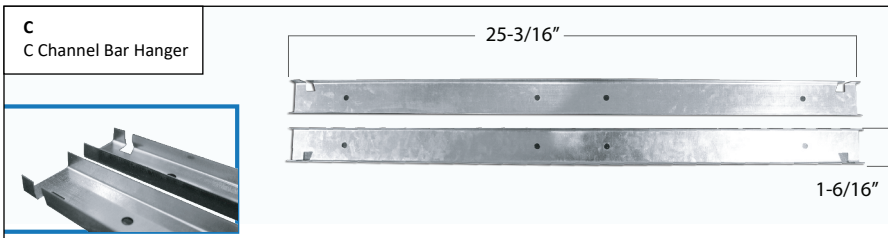
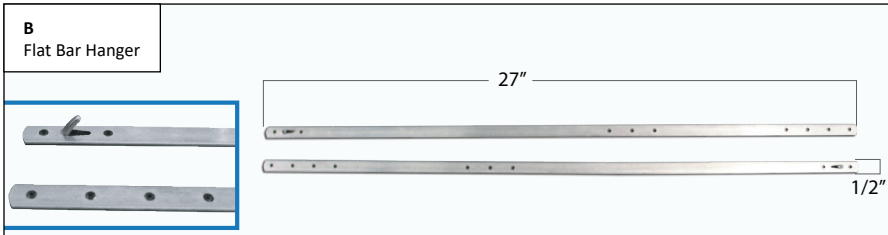
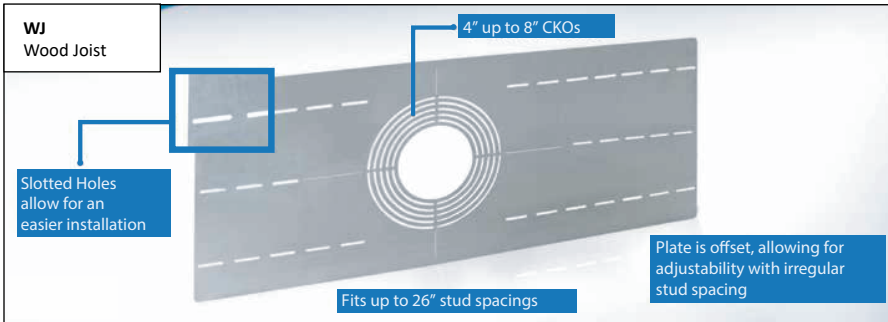

UNIVERSAL BAR HANGER

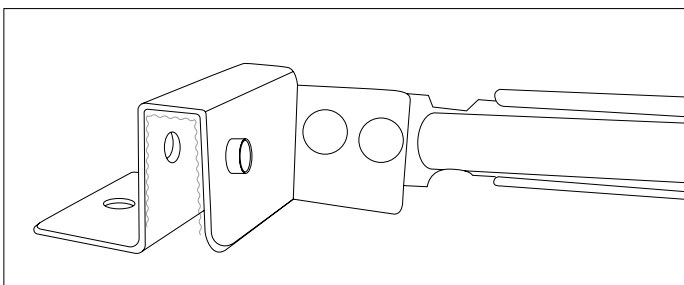

- Compatible Ceiling
- Hat Channel
 - T-Bar
 - C Channel
 - Laminated Wood
 - Quick-Span
 - I-Beam
 - Standard Joist