

USE OF PRODUCT

The 4" Prime series is the ideal product for architectural energy efficient lighting in commercial and residential applications. Available options include die-cast or anodized aluminum trims, various temperatures, optics, lumen outputs, and dimmable drivers.

LED ENGINE

LED engine available in 2700K, 3000K, 3500K, or 4000K in standard 90+ CRI. 2-step MacAdam ellipse allows for color consistency between fixtures. The LED is mounted to an aluminum heat sink for maximum life output and

FRAME CONSTRUCTION

Non-IC housing are constructed from a 16-gauge heavy-duty, powder-coated cold-rolled steel frame and includes a junction box with 1/2" knockouts. Butterfly brackets (included) accommodate universal bar hanger

OPTICAL LENS

Field replaceable optical lenses are available in 15°, 24°, 30°, 35°, 40°, 50° and 60°. Easily achieve narrow spot to wide flood beam pattern.

DIMMING

Available in nine driver selections. (ID) Standard all-inclusive ELV (120V), Triac (120V), and 0-10V (120-277V) dimming driver called Intelligent Drive, (EEI) eldoLED 1% Dim 0-10V, (EES) eldoLED 1% Dim 0-10V (120-277V) and Triac (120V), Max 20W, (EDIO) eldoLED 0.1 Dim 0-10V, (EDID) eldoLED 0.1% Dim DALI, (EDD) eldoLED 1% Dim DALI2, (LDE1) Lutron Hi-Lume 1% Ecosystem with Soft-on, Fade-to-Black Dimming, (L3DA) Hi-Lume 1% Ecosystem/3-Wire L3D Driver, (PEQO) Lutron Hi-Lume Premier Ecosystem 0.1% with Soft-on, Fade-to-Black Dimming.

THERMAL MANAGEMENT

Fixture location ambient temperature should not exceed -20° to 40°C.

BEVEL

Bevel includes standard frosted acrylic diffuser. Remove standard frosted acrylic diffuser in field for 7% lumens increase. Consult factory for made-to-order finishes. Wet location for bathrooms and showers with standard lens on trim.

EMERGENCY BATTERY

Optional 8W (≈800 lm) or 15W (≈1,500 lm) emergency battery (EM) provides light for a minimum of 90 minutes. EM is replaceable from below the ceiling.

LABELS/COMPLIANCE/WARRANTY

- CSA listed for US and Canada
- Energy Star certified product
- Dry/Damp/Wet location rated
- State of California Title 24 and JA8 compliant
- 5-year limited warranty



GENERAL PERFORMANCE CHART

*Detailed performance chart may be found on page 3

	6W	9W	12W	15W	20W	24W	28W	32W	33W	35W	40W	48W	56W
Initial Lumens	955	1296	1618	2015	2422	2799	3128	3405	4090	4626	4967	5786	6472
Delivered Lumens	424-829	581-1135	736-1436	907-1744	1101-2122	1279-2470	1442-2868	1589-3096	1815-3518	2097-3879	2274-4218	2636-4887	2953-5484

* Values are listed at 3000K, 90+ CRI with a white bevel & trim.
Delivered lumens range based on beam spread.
Performance may vary +/- 5%

BEAM SPREAD

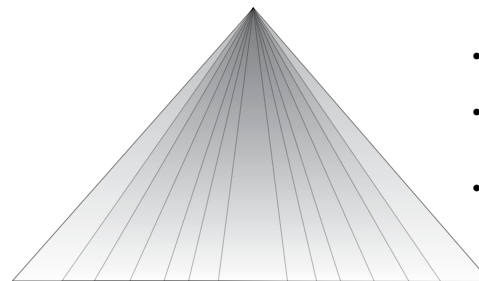

Available optics: 15° 24° 30° 35° 40° 50° 60°

- Field replaceable TIR optics
- Easily achieve narrow spot to wide flood beam pattern
- Optional filters available upon request

PRIME FAMILY OF PRODUCTS

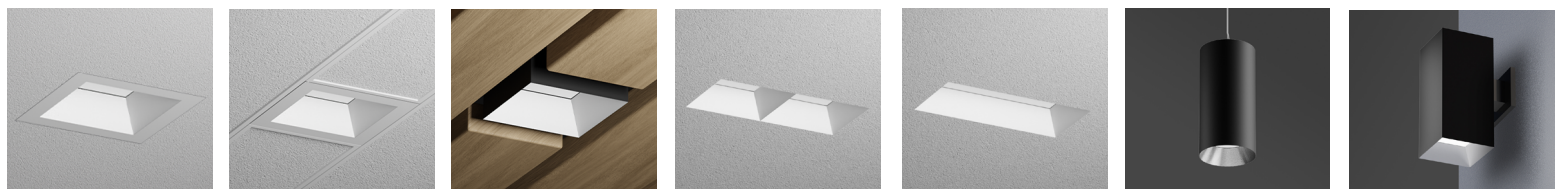

Downlight TechZone® WoodWorks® Multiple Dedicated Bevel Multiple Open Bevel Cylinder Square Luminaire

ORDERING INFORMATION

Series	Wattage	Dimming	Color Temperature	Optical Lens	Filter
RPA4	6W - 6 Watt 9W - 9 Watt 12W - 12 Watt 15W - 15 Watt 20W - 20 Watt 24W - 24 Watt 28W - 28 Watt 32W - 32 Watt 33W - 33 Watt 35W - 35 Watt 40W - 40 Watt 48W - 48 Watt 56W - 56 Watt	ID¹ - Standard All-Inclusive ELV, Triac, and 0-10V Dimming Driver (Intelligent Drive) EI² - eldoLED 1% Dim (0-10V) EI³ - eldoLED 1% Dim 0-10V (120-277V), Triac (120V), Max 20W EDIO² - eldoLED 0.1% Dim (0-10V) EDID² - eldoLED 0.1% Dim (DALI) EDD² - eldoLED 1% Dim (DALI2) LDE1⁴ - Lutron Hi-Lume 1% Ecosystem with Soft-on, Fade-to-Black Dimming L3DA⁴ - Hi-Lume 1% Ecosystem/3-Wire L3D Driver PEQ0 - Lutron Hi-Lume Premier Ecosystem 0.1% with Soft-on, Fade-to-Black Dimming	27K - 2700K 30K - 3000K 35K - 3500K 40K - 4000K	15^{5,6} - 15° 24⁶ - 24° 30 - 30° 35 - 35° 40 - 40° 50 - 50° 60 - 60°	None - Included F - Frosted Filter H - Honey Comb S - Solite Filter L - Linear Filter

Housing Type	Collar	Woodworks Collar Finish	Module Type	Frame Accessories
WW8177 - Woodwork No. 8177	CR15 - 1.5" Depth MTO - Made To Order	B⁷ - Black BZ - Bronze MTO - Made To Order	AMH - Adjustable	UH - Universal Bar Hanger

Options	Wireless Controls Options	Notes
ER8W - Emergency Battery with Remote Switch (800 lm) EI8W - Emergency Battery with Integral Switch (800 lm) ER15W - Emergency Battery with Remote Switch (1,500 lm) EI15W - Emergency Battery with Integral Switch (1,500 lm)	AWN - Athena Wireless (Lutron) CLM - Connected Lighting Module (Legrand Wattstopper)	<ol style="list-style-type: none"> Intelligent Drive is the standard driver. Must specify logarithmic or linear eldoLED driver. Driver available up to 20W and programmed only in linear mode. Not offered in 6W. Available up to 32W only. 15° and 24° spread without lens on trim. Black is the standard color.

TRIM ORDERING INFORMATION

Bevel Finish	Bevel
4" Round Flangeless Regress Large Opening	4RLOW - White bevel 4RLOH - Haze bevel 4RLOWE - Wheat bevel 4RLOS - Specular clear bevel 4RLOB - Black bevel 4RLOMTO - Made to order
4" Round Flangeless Accent	4RLAW - White bevel 4RLAH - Haze bevel 4RLAWE - Wheat bevel 4RLAS - Specular clear bevel 4RLAB - Black bevel 4RLAMTO - Made to order

PERFORMANCE CHART

Optics		^{1,2} 15°	² 24°	30°	35°	40°	50°	60°
6W	Initial Lumens	955	955	955	955	955	955	955
	Delivered Lumens	803	829	672	708	744	617	424
	UGR			9.8	10.3	12.7	16.4	18.2
9W	Initial Lumens	1296	1296	1296	1296	1296	1296	1296
	Delivered Lumens	1097	1135	920	968	1017	854	581
	UGR			11.2	11.8	14.1	17.8	19.7
12W	Initial Lumens	1618	1618	1618	1618	1618	1618	1618
	Delivered Lumens	1387	1436	1161	1226	1277	1070	736
	UGR			11.8	12.5	14.7	18.4	20.4
15W	Initial Lumens	2015	2015	2015	2015	2015	2015	2015
	Delivered Lumens	1632	1744	1485	1561	1564	1308	907
	UGR			12.5	13.2	15.4	19.1	21.1
20W	Initial Lumens	2422	2422	2422	2422	2422	2422	2422
	Delivered Lumens	1976	2122	1805	1897	1904	1592	1101
	UGR			13.3	13.8	16.1	19.8	21.8
24W	Initial Lumens	2799	2799	2799	2799	2799	2799	2799
	Delivered Lumens	2300	2470	2099	2207	2217	1856	1279
	UGR			13.8	14.4	16.7	20.3	22.3
28W	Initial Lumens	3128	3128	3128	3128	3128	3128	3128
	Delivered Lumens	2820	2868	2365	2487	2500	2095	1442
	UGR			14.3	14.8	17.1	20.8	22.7
32W	Initial Lumens	3405	3405	3405	3405	3405	3405	3405
	Delivered Lumens	2921	3096	2603	2738	2753	2307	1589
	UGR			14.6	15.1	17.4	21.1	23
33W	Initial Lumens		4090		4090	4090	4090	4090
	Delivered Lumens		3518		2928	3031	3041	1815
	UGR				17.4	17.5	19.3	22.9
35W	Initial Lumens		4626		4626	4626	4626	4626
	Delivered Lumens		3879		3208	3352	3381	2097
	UGR				17.6	17.8	19.7	23.5
40W	Initial Lumens		4967		4967	4967	4967	4967
	Delivered Lumens		4218		3500	3657	3705	2274
	UGR				17.9	18.1	20	24
48W	Initial Lumens		5765		5765	5765	5765	5765
	Delivered Lumens		4887		4062	4245	4312	2636
	UGR				18.4	18.7	20.5	24.3
56W	Initial Lumens		6472		6472	6472	6472	6472
	Delivered Lumens		5484		4563	4772	4857	2953
	UGR				18.8	19.1	20.9	24.7

* Values are listed at 3000K, 90+ CRI with a white bevel & trim.

Notes

1. Available in 6W-32W only
2. 15° and 24° spread without lens on trim

COLOR TEMPERATURE MULTIPLIER FOR DELIVERED LUMENS

2700K	3000K	3500K	4000K
0.95	1.00	1.04	1.07

HOUSING DIMENSIONS 6W-20W

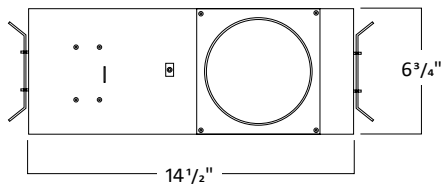

WW8176 - Woodwork No. 8176

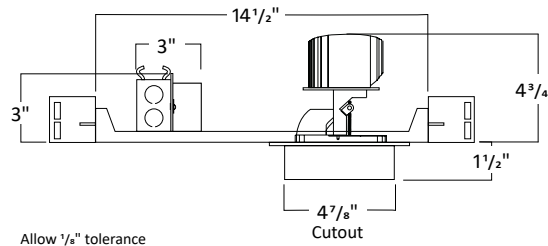

Allow 1/8" tolerance

HOUSING DIMENSIONS 24W-56W

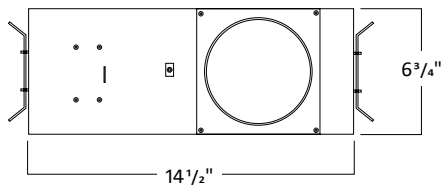

WW8176 - Woodwork No. 8176

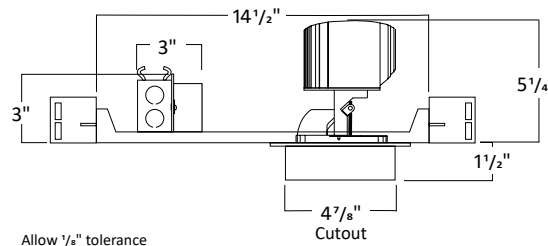

Allow 1/8" tolerance

FRAME ACCESSORIES

UNIVERSAL BAR HANGER

COMPATIBLE CEILING

- Hat Channel
- T-Bar
- C-Channel
- Laminated Wood
- Quick-Span
- I-Beam
- Standard Joist

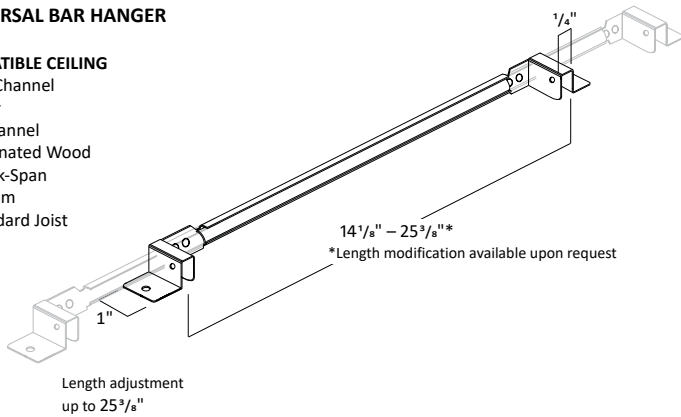

LED MODULE

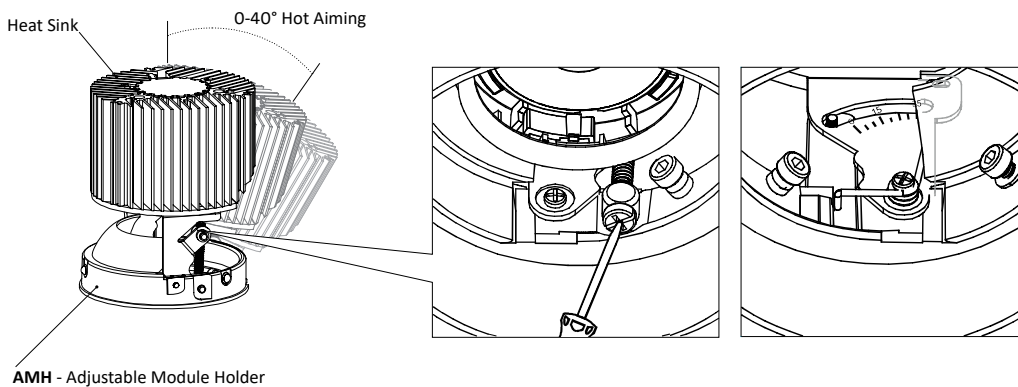

FILTERS

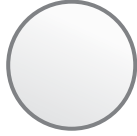

Frosted Filter

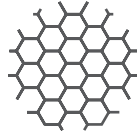

Honey Comb

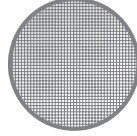

Solite Filter



Linear Filter

TRIM DIMENSIONS

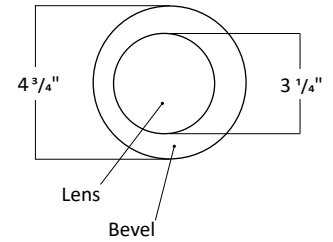
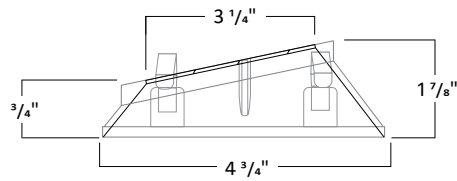
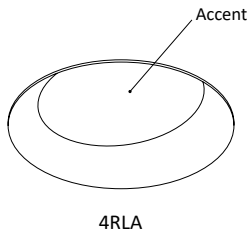
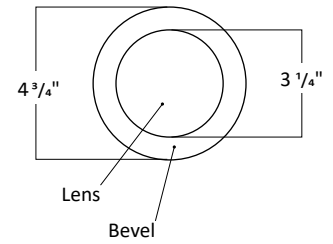
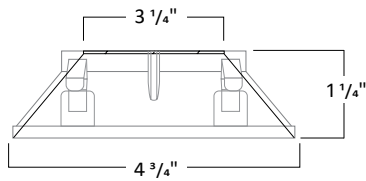
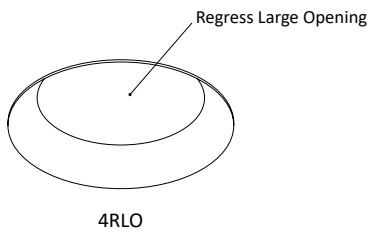

TRIM FINISH



*Consult Factory for Made to Order Finishes