

## 4" LED ARCHITECTURAL SQUARE FLANGE DOWNLIGHT AMBER REMODEL



### GENERAL INFORMATION

#### USE OF PRODUCT

Amber LED luminaires deliver a distinctive warm appearance while supporting applications where visual comfort, reduced glare, and environmental sensitivity are priorities. Well suited for architectural, landscape, hospitality, and public-space lighting projects.

#### LED ENGINE

High-performance amber LED engine delivers consistent illumination with excellent optical control and long service life. LEDs are selected for color consistency and reliability to ensure uniform appearance across installations.

#### OPTICAL LENS

Field replaceable optical lenses are available in 30°, 35°, 40°, 50° and 70°. Easily achieve narrow spot to wide flood beam pattern.

#### ADJUSTMENT

- Housing supports 359° locking rotation.
- Aperture collar compatible up to 1½" ceiling thickness. Consult factory for made-to-order aperture collars exceeding 1½".

#### DIMMING

Available in five driver selections. (ID) Standard all-inclusive ELV (120V), Triac (120V), and 0–10V (120–277V) dimming driver called Intelligent Drive. (EEIS) eldoLED 1% Dim 0–10V (120–277V), Triac (120V), Max 20W. (EDIO) eldoLED 0.1% Dim (0–10V), 120–277V. (EDID) eldoLED 0.1% Dim (DALI). (EDD) eldoLED 1% Dim (DALI2). Drivers are accessible from below the ceiling.

#### TRIM

Flange trims available in die-cast. Consult factory for made-to-order finishes. Wet location for bathrooms and showers with standard lens on trim.

#### EMERGENCY BATTERY

Optional Emergency Battery (EM) available in 4W (≈400 lm), 8W (≈800 lm), or 15W (≈1,500 lm) available for a minimum of 90 minutes. EM is replaceable from below the ceiling.

#### LABELS/COMPLIANCE/WARRANTY

- CSA listed for US and Canada
- Dry/Damp/Wet location rated
- 5-year limited warranty



### GENERAL PERFORMANCE

Color	Dominant Wavelength Range				Minimum Luminous Flux (lm) @ 350 mA	
	Minimum		Maximum		Group	lux (lm)
	Group	DWL (nm)	Group	DWL (nm)		
Amber	A2	585	A3	595	P4	80.6
					P3	73.9
					P2	67.2
					N4	62
					N3	56.8

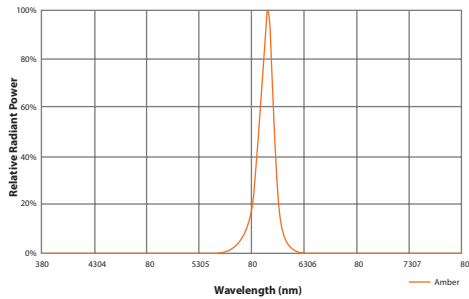

### BEAM SPREAD

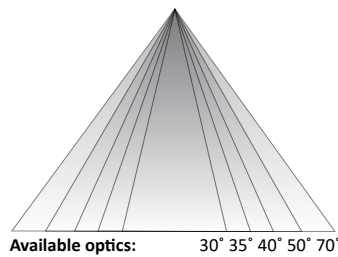

- Field replaceable TIR optics
- Easily achieve narrow spot to wide flood beam pattern
- Optional filters available upon request

### PRIME FAMILY OF PRODUCTS

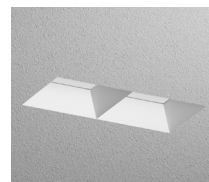

Downlight

TechZone®

WoodWorks®

Multiple Dedicated Bevel

Multiple Open Bevel

Cylinder

Square Luminaire

## 4" LED ARCHITECTURAL SQUARE FLANGE DOWNLIGHT AMBER REMODEL

### ORDERING INFORMATION

Series	Wattage	Dimming	Color Temperature	Optical Lens	Filter
RPA4	15W - 15 Watt (500lm)	<b>ID<sup>1</sup></b> - Standard All-Inclusive ELV(120V), Triac(120V), and 0-10V(120-277V) Dimming Driver (Intelligent Drive) <b>EEIS<sup>2,3</sup></b> - eldoLED 1% Dim 0-10V (120-127V), Triac (120V) <b>EDIO<sup>2</sup></b> - eldoLED 0.1% Dim (0-10V) <b>EDID<sup>2</sup></b> - eldoLED 0.1% Dim (DALI) <b>EDD<sup>2</sup></b> - eldoLED 1% Dim (DALI2)	A - Amber	<b>30</b> - 30° <b>35</b> - 35° <b>40</b> - 40° <b>50</b> - 50° <b>70</b> - 70°	<b>None</b> - Included <b>F</b> - Frosted Filter <b>H</b> - Honey Comb <b>S</b> - Solite Filter <b>L</b> - Linear Filter

Housing Type	Module Type	Options
FRS - Remodel Square	FMH - Downlight	<b>ER4W</b> - Emergency Battery with Remote Test Switch (400 lm) <b>EI4W</b> - Emergency Battery with Integral Test Switch (400 lm) <b>ER8W</b> - Emergency Battery with Remote Test Switch (800 lm) <b>EI8W</b> - Emergency Battery with Integral Test Switch (800 lm) <b>ER15W</b> - Emergency Battery with Remote Test Switch (1500 lm) <b>EI15W</b> - Emergency Battery with Integral Test Switch (1500 lm)

- Notes
- Intelligent Drive is the standard driver.
  - Must specify logarithmic or linear eldoLED driver.
  - Available up to 20W only.

### TRIM ORDERING INFORMATION

Bevel / Flange Finish (one piece)	Trim Type	Bevel / Flange finish
4" Square Flange Regress Large Opening	4SFOW-W	White bevel / white flange
	4SFOH-W	Haze bevel / white flange
	4SFOB-B	Black bevel / black flange
	4SFOH-H	Haze bevel / haze flange
	4SFOS-S	Specular clear bevel / specular clear flange
	4SFOS-W	Specular clear bevel / white flange
	4SFOWE-WE	Wheat bevel / wheat flange
	4SFOMTO	Made to order

### 4SFO REGRESS LARGE OPENING

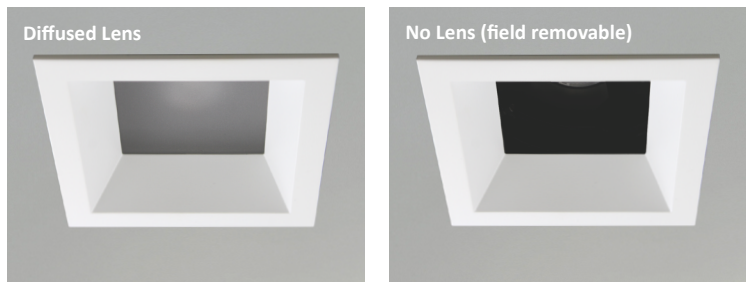

- IES files are based on the large opening trim with diffused lens.
- Not suitable for wet locations
- Increase in lumens by approximately 7%

## 4" LED ARCHITECTURAL SQUARE FLANGE DOWNLIGHT AMBER REMODEL

### 4" PRIME REMODEL DIMENSIONS

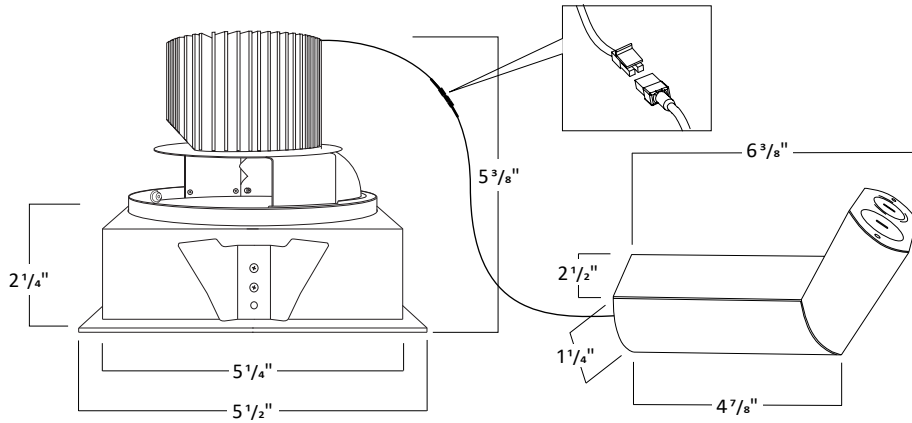

### FILTERS

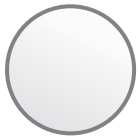

Frosted Filter



Honey Comb

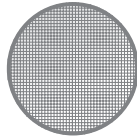

Solite Filter



Linear Filter

### TRIM DIMENSIONS

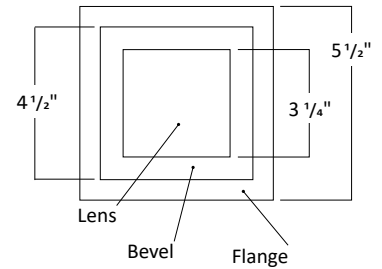
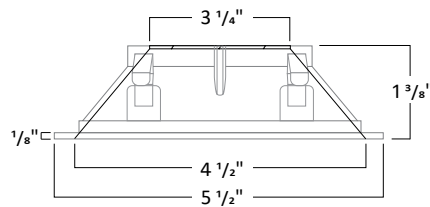
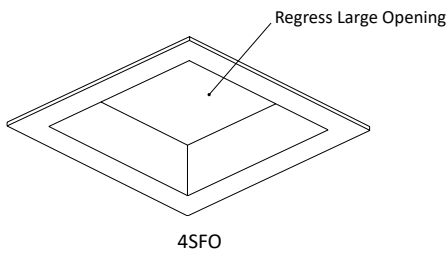

### TRIM FINISH



White



Black



Haze



Specular Clear



Wheat

\*Consult Factory for Made to Order Finishes