



GENERAL INFORMATION

USE OF PRODUCT

The 3" Prime Downlight is a small aperture fixture with a super shallow housing height of 2½", which is ideal for residential and commercial applications. Available options include die-cast or spun aluminum trims, various temperatures, optics, and dimmable drivers.

LED ENGINE

LED engine available with CREE LEDs in 2700K, 3000K, 3500K, or 4000K in standard 90+ CRI. 2-step MacAdam ellipse allows for color consistency between fixtures. The LED is mounted to an aluminum heat sink for maximum life output and thermal management. LED engine is accessible from below the ceiling.

FRAME CONSTRUCTION

IC-rated super shallow housing is constructed from a 16-gauge heavy-duty, powder-coated cold-rolled steel frame and includes a junction box with ½" knockouts. Butterfly brackets (included) accommodate adjustable bar hanger (order separately).

ADJUSTMENT

- Housing supports 359° locking rotation.
- Aperture collar compatible up to 1½" ceiling thickness. Consult factory for made-to-order aperture collars exceeding 1½".

OPTICAL LENS

Field replaceable optical lenses are available in 12°, 25°, 30°, 40°, 50°, and 70°. Easily achieve narrow spot to wide flood beam pattern.

DIMMING

Available in nine driver selections. (ID) Standard all-inclusive ELV (120V), Triac (120V), and 0–10V (120–277V) dimming driver called Intelligent Drive, (EEI) eldoLED 1% Dim 0-10V, (EES) eldoLED 1% Dim 0-10V (120-277V) and Triac (120V), (EDIO) eldoLED 0.1 Dim 0-10V, (EDID) eldoLED 0.1% Dim DALI, (EDD) eldoLED 1% Dim DALI2.

TRIM

Flange trims available in die-cast or spun aluminum. Trim includes standard frosted acrylic diffuser. Remove standard frosted acrylic diffuser in field for 7% lumens increase. Consult factory for made-to-order finishes. Wet location for bathrooms and showers with standard lens on trim.

EMERGENCY BATTERY

Optional 8W Emergency Battery (EM) available in 8W (≈800 lm) available for a minimum of 90 minutes. Ceiling access is required to replace the EM unit

LABELS/COMPLIANCE/WARRANTY

- CSA listed for US and Canada.
- Energy Star certified product.
- Dry/Damp/Wet location rated.
- State of California Title 24 and JA8 compliant.
- 5-year limited warranty.



GENERAL PERFORMANCE CHART

*Detailed performance chart may be found on page 3

	6W	9W	12W	15W
Initial Lumens	657/955	890/1296	1122/1618	1267/2015
Delivered Lumens	586-755	794-1038	999-1319	1060-1642

* Values are listed at 3000K, 90+ CRI with a white bevel & trim.
Delivered lumens range based on beam spread.
Performance may vary +/- 5%

BEAM SPREAD

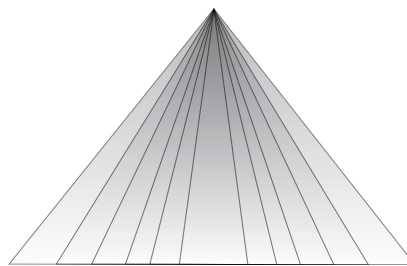

Available optics: 12° 25° 30° 40° 50° 70°

- Field replaceable TIR optics
- Easily achieve narrow spot to wide flood beam pattern
- Optional filters available upon request

PRIME FAMILY OF PRODUCTS

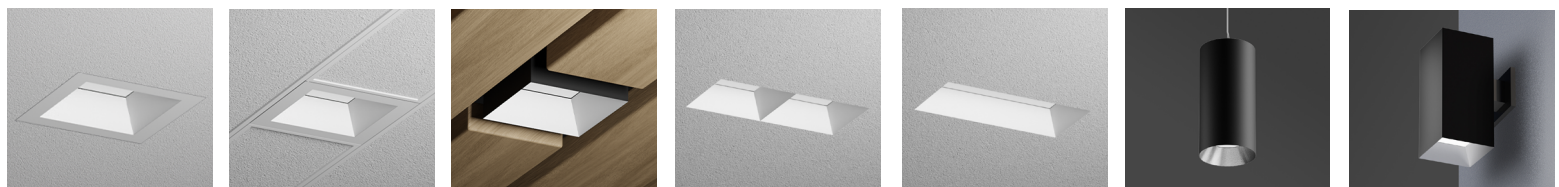

Downlight TechZone® WoodWorks® Multiple Dedicated Bevel Multiple Open Bevel Cylinder Square Luminaire

3" LED ARCHITECTURAL SUPER SHALLOW ROUND FLANGE DOWNLIGHT

ORDERING INFORMATION

Series	Wattage	Dimming	Color Temperature	Optical Lens	Filter
RPA3S	6W - 6 Watt 9W - 9 Watt 12W - 12 Watt 15W - 15 Watt	ID ¹ - Standard All-Inclusive ELV, Triac, and 0-10V Dimming Driver (Intelligent Drive) EEI ² - eldoLED 1% Dim (0-10V) EEIS ³ - eldoLED 1% Dim 0-10V (120-277V), Triac (120V), Max 20W EDIO ² - eldoLED 0.1% Dim (0-10V) EDID ² - eldoLED 0.1% Dim (DALI) EDD ² - eldoLED 1% Dim (DALI2)	27K - 2700K 30K - 3000K 35K - 3500K 40K - 4000K	12 ³ - 12° 25 - 25° 30 - 30° 40 - 40° 50 - 50° 70 - 70°	Blank - None F - Frosted Filter H - Honey Comb S - Solite Filter L - Linear Filter
Housing Type	Collar	Frame Accessories	Options		
IC - IC Super Shallow New Construction	CR15 - 1.5" Depth MTO ⁴ - Made To Order	AH - Adjustable Bar Hanger	ER8W ⁵ - Emergency Battery with Remote test switch (800 lm) CP - Chicago Plenum		

TRIM ORDERING INFORMATION

DIE-CAST

Bevel / Flange Finish	Trim Type	Bevel	Flange	Notes
May be mixed and matched				
3" Round Flange Regress Small Opening	3RFO-CS 3RFO-CS 3RFO-CS 3RFO-CS 3RFO-CS	W - White B - Black H - Haze BZ - Bronze MTO - Made To Order	W - White B - Black BZ - Bronze MTO - Made To Order	<ol style="list-style-type: none"> Intelligent Drive is the standard driver. Must specify logarithmic or linear eldoLED driver. 12° spread without lens on trim. Collar depth may be increased from the standard 1.5" depth; reduction below 1.5" is not available. Ceiling access is required to replace the EM unit.
3" Round Flange Regress Large Opening	3RFO-CL 3RFO-CL 3RFO-CL 3RFO-CL 3RFO-CL	W - White B - Black H - Haze BZ - Bronze MTO - Made To Order	W - White B - Black BZ - Bronze MTO - Made To Order	

SPUN ALUMINUM (SELF-FLANGED)

Bevel / Flange Finish	Trim Type	Self-Flanged
3" Round Flange Regress Small Opening	3RFO-AS 3RFO-AS 3RFO-AS	H - Haze C - Clear MTO - Made To Order
3" Round Flange Regress Large Opening	3RFO-AL 3RFO-AL 3RFO-AL	H - Haze C - Clear MTO - Made To Order

PERFORMANCE CHART

Optics		¹ 12°	25°	30°	40°	50°	70°
6W	Initial Lumens	657	955	955	955	955	955
	Delivered Lumens	586	718	755	754	726	602
	UGR		13.5	13	16.4	19.1	21
9W	Initial Lumens	890	1296	1296	1296	1296	1296
	Delivered Lumens	794	978	1034	1038	984	825
	UGR		14.6	14.3	17.7	19.6	22.3
12W	Initial Lumens	1122	1618	1618	1618	1618	1618
	Delivered Lumens	999	1225	1314	1319	1238	1051
	UGR		15.2	15.1	18.3	21.2	22.9
15W	Initial Lumens	1267	2015	2015	2015	2015	2015
	Delivered Lumens	1060	1470	1628	1642	1565	1227
	UGR		15.9	15.8	19	21.9	23.6

* Values are listed at 3000K, 90+ CRI with a white bevel & trim.

Notes

1. 12° spread without lens on trim

COLOR TEMPERATURE MULTIPLIER FOR DELIVERED LUMENS

2700K	3000K	3500K	4000K
0.95	1.00	1.04	1.07

3RFO-CS REGRESS SMALL OPENING

3RFO-CL REGRESS LARGE OPENING



- IES files are based on the large opening trim with diffused lens.

- Not suitable for wet locations
- Increase in lumens by approximately 7%

- IES files are based on the large opening trim with diffused lens.

- Not suitable for wet locations
- Increase in lumens by approximately 7%

HOUSING DIMENSIONS

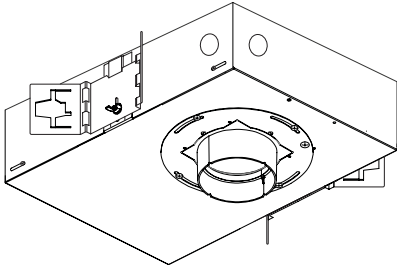

IC - IC Super Shallow New Construction

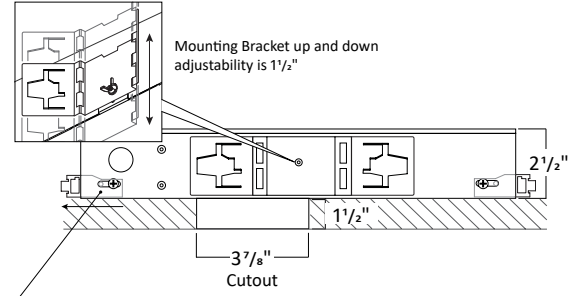
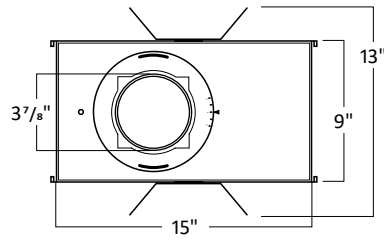

Extendable Ceiling Mount Bracket
(Compatible with Universal Bar Hanger)

1. Consult factory for Made to Order collar height
2. Allow 1/8" tolerance

FRAME ACCESSORIES

AH - Adjustable Bar Hanger

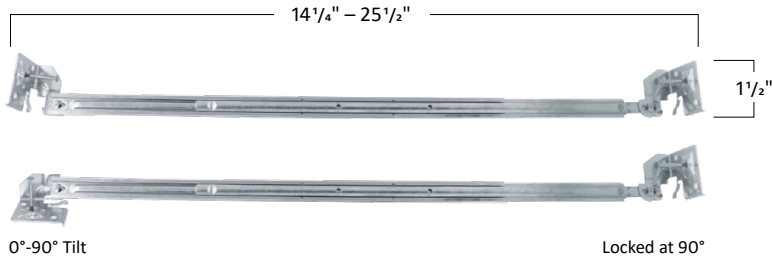
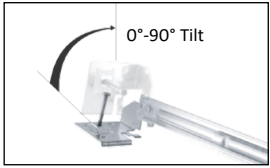

FILTERS

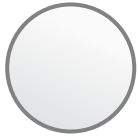

Frosted Filter



Honey Comb

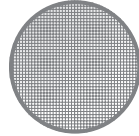

Solite Filter



Linear Filter

3" LED ARCHITECTURAL SUPER SHALLOW ROUND FLANGE DOWNLIGHT

TRIM DIMENSIONS

DIE-CAST

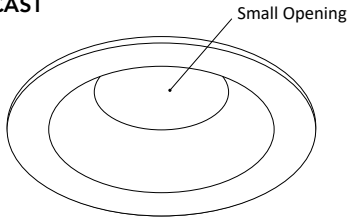

3RFO-CS

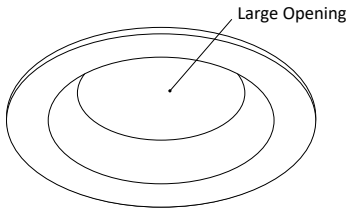
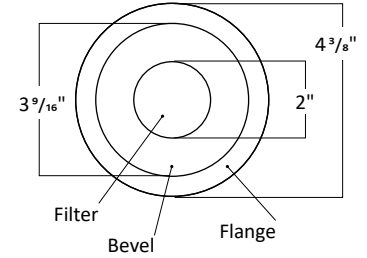
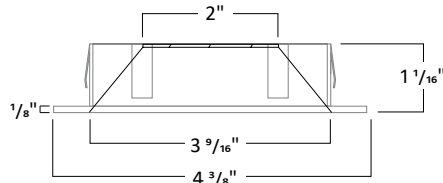

3RFO-CL

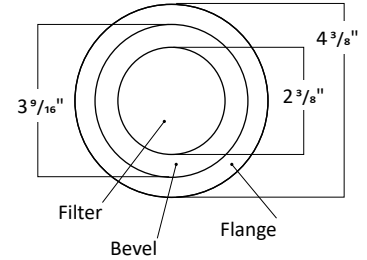
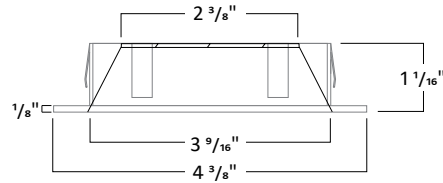

TRIM FINISH

May be mixed and matched



*Consult Factory for Made to Order Finishes

SPUN ALUMINUM (SELF-FLANGED)

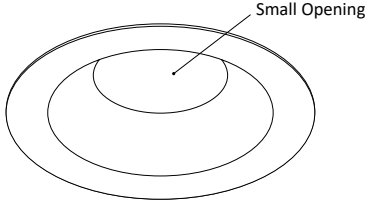

3RFO-AS

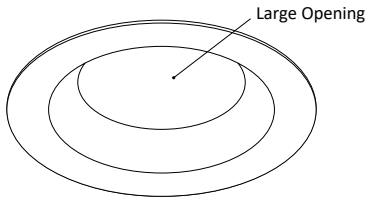
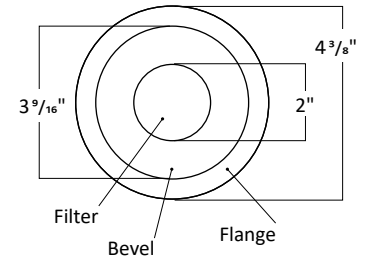
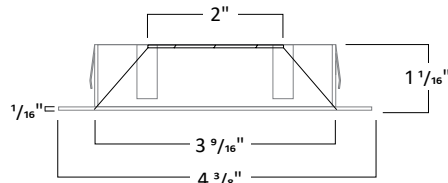

3RFO-AL

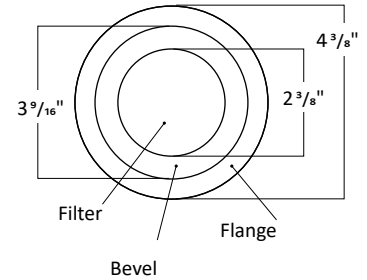
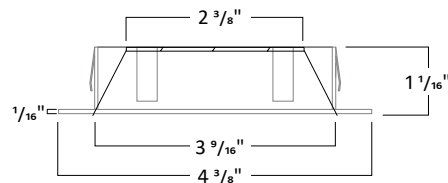

TRIM FINISH



*Consult Factory for Made to Order Finishes

REMOTE EMERGENCY BATTERY

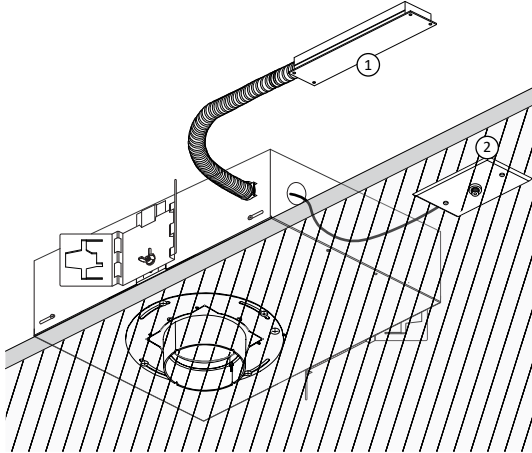

IC - Super Shallow New Construction

ER8W is an 8W Emergency Battery that is remote to the fixture with a remote test switch. Ceiling access is required for replacement purposes

- 1. Remote Emergency Battery
- 2. Remote Test Switch