

3" ARCHITECTURAL SQUARE FLANGE DOWNLIGHT COMPATIBLE WITH 6" TECHZONE® CEILINGS (SILHOUETTE®, SUPRAFINE®, INTERLUDE®, OR PRELUDE®) BY ARMSTRONG®

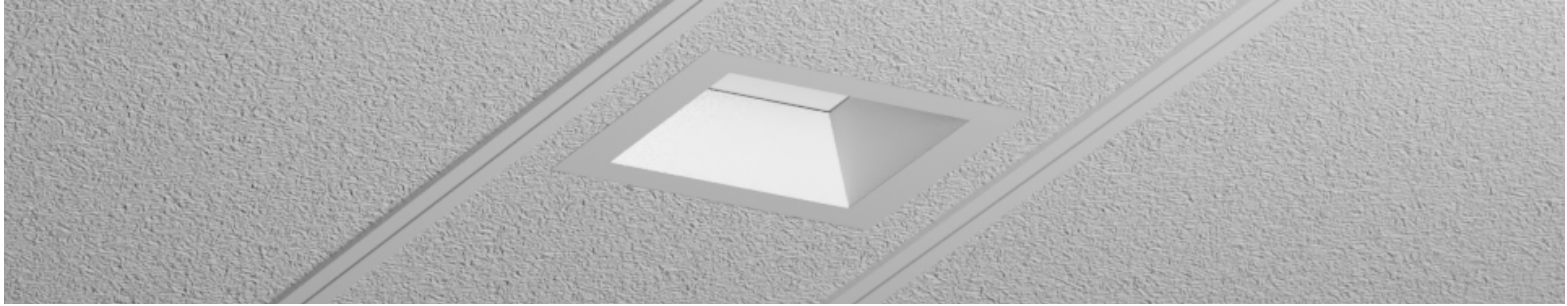

USE OF PRODUCT

The 3" Prime Downlight is a small aperture fixture which is compatible with 6" TechZone® ceilings. Allows for seamless installation and integration of luminaires with Silhouette®, Suprafine®, Interlude®, or Prelude® ceiling types offered by Armstrong®. Available options include die-cast trims, various temperatures, optics, and dimmable drivers.

LED ENGINE

LED engine available with CREE LEDs in 2700K, 3000K, 3500K, or 4000K in standard 90+ CRI. 2-step MacAdam ellipse allows for color consistency between fixtures. The LED is mounted to an aluminum heat sink for maximum life output and thermal management. LED engine is accessible from below the ceiling.

FRAME CONSTRUCTION

Non IC housing constructed from 20-gauge cold-rolled steel and includes a junction box with ½" knockouts. Integrated mounting brackets that will snap directly into 6" TechZone® ceiling grids. Compatible with the following series: Silhouette®, Suprafine®, Interlude®, or Prelude®.

GENERAL PERFORMANCE CHART

*Detailed performance chart may be found on page 3

| | 6W | 9W | 12W | 15W | 20W | 24W | 28W | 32W |
|-------------------------|---------|----------|-----------|-----------|-----------|-----------|-----------|-----------|
| Initial Lumens | 657/955 | 890/1296 | 1122/1618 | 1267/2015 | 1485/2422 | 2799 | 3128 | 3405 |
| Delivered Lumens | 586-755 | 794-1038 | 999-1319 | 1060-1642 | 1244-1985 | 1713-2296 | 1914-2569 | 2080-2785 |

* Values are listed at 3000K, 90+ CRI with a white bevel & trim.
Delivered lumens range based on beam spread.
Performance may vary +/- 5%

OPTICAL LENS

Field replaceable optical lenses are available in 12°, 25°, 30°, 40°, 50°, and 70°. Easily achieve narrow spot to wide flood beam pattern.

DIMMING

Available in six driver selections. (ID) Standard all-inclusive ELV (120V), Triac (120V), and 0–10V (120–277V) dimming driver called Intelligent Drive, 120–277V. (LDE1) Lutron Hi-Lume 1% Ecosystem with soft-on, fade-to-black dimming, 120–277V. (L3DA) Hi-lume 1% EcoSystem/3-Wire L3D Driver (EEI) eldoLED Eco 1% Dim (0–10V), 120–277V. (EDIO) eldoLED Solo 0.1% Dim (0–10V), 120–277V. (EDID) eldoLED Solo 0.1% Dim (DALI), 120–277V. Driver accessible from below ceiling.

THERMAL MANAGEMENT

Fixture location ambient temperature should not exceed -20° to 40°C.

TRIM

Flange trims available in die-cast and includes standard frosted acrylic diffuser. Remove standard frosted acrylic diffuser in field for 7% lumens increase. Consult factory for made-to-order finishes. Wet location for bathrooms and showers with standard lens on trim.

EMERGENCY BATTERY

Optional emergency battery available for a minimum of 90 minutes with remote test switch in 800 delivered lumens.

LABELS/COMPLIANCE/WARRANTY

- CSA Listed for US and Canada.
- Energy Star certified product.
- Dry/Damp location rated.
- 5-year limited warranty.



BEAM SPREAD

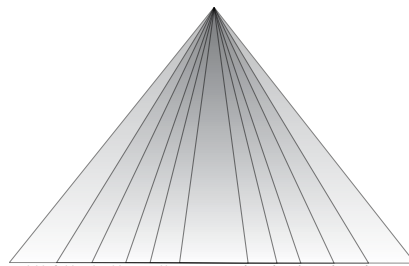

Available optics: 12° 25° 30° 40° 50° 70°

- Field replaceable TIR optics
- Easily achieve narrow spot to wide flood beam pattern
- Optional filters available upon request

PRIME FAMILY OF PRODUCTS

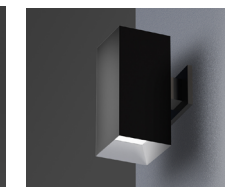
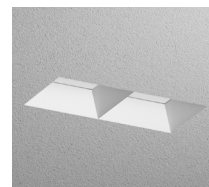

Downlight

TechZone®

WoodWorks®

Multiple Dedicated Bevel

Multiple Open Bevel

Cylinder

Square Luminaire

3" ARCHITECTURAL SQUARE FLANGE DOWNLIGHT COMPATIBLE WITH 6" TECHZONE® CEILINGS (SILHOUETTE®, SUPRAFINE®, INTERLUDE®, OR PRELUDE®) BY ARMSTRONG®

ORDERING INFORMATION

| Series | Wattage | Dimming | Color Temperature | Optical Lens | Filter |
|---------------|---|---|-------------------|-----------------------|--------------------|
| RPA3 | 6W - 6 Watt | ID ¹ - Standard All-Inclusive ELV, Triac, and 0-10V Dimming Driver (Intelligent Drive) | 27 - 2700K | 12 ⁴ - 12° | None - Leave Blank |
| | 9W - 9 Watt | | 30 - 3000K | 25 - 25° | F - Frosted Filter |
| | 12W - 12 Watt | LDE1 ² - Lutron Hi-Lume 1% Ecosystem with Soft-on, Fade-to-Black Dimming | 35 - 3500K | 30 - 30° | H - Honey Comb |
| | 15W - 15 Watt | | 40 - 4000K | 40 - 40° | S - Solite Filter |
| | 20W - 20 Watt | L3DA - Hi-lume 1% EcoSystem/3-Wire L3D Driver | | 50 - 50° | L - Linear Filter |
| | 24W - 24 Watt | EEI ³ - eldoLED Eco 1% Dim (0-10V) | | 70 - 70° | |
| | 28W - 28 Watt | EDI ³ - eldoLED Solo 0.1% Dim (0-10V) | | | |
| 32W - 32 Watt | EDI ³ - eldoLED Solo 0.1% Dim (DALI) | | | | |

| Housing Type | Collar | Module Type | Frame Accessories | Options |
|----------------------------|---|-----------------|---------------------------|---|
| TZ6 - 6" TechZone® Ceiling | CR10 - 1.0" Depth CR15 - 1.5" Depth MTO - Made To Order | FMH - Downlight | UH - Universal Bar Hanger | ER8W - Emergency Battery with Remote test switch (800 lm) ER15W - Emergency Battery with Remote test switch (1,500 lm) |

TRIM ORDERING INFORMATION

DIE-CAST

| Bevel / Flange Finish | Trim Type | Bevel | Flange |
|--------------------------|--|---------|---------------------|
| May be mixed and matched | 3" Square Flange Regress Small Opening | 3SFO-CS | W - White |
| | | 3SFO-CS | B - Black |
| | | 3SFO-CS | H - Haze |
| | | 3SFO-CS | BZ - Bronze |
| | | 3SFO-CS | C - Clear |
| | | 3SFO-CS | MTO - Made To Order |
| | 3" Square Flange Regress Large Opening | 3SFO-CL | W - White |
| | | 3SFO-CL | B - Black |
| | | 3SFO-CL | H - Haze |
| | | 3SFO-CL | BZ - Bronze |
| | | 3SFO-CL | C - Clear |
| | | 3SFO-CL | MTO - Made To Order |

Notes

- Intelligent Drive is the standard driver.
- Not offered in 6W.
- Must specify logarithmic or linear eldoLED driver.
- 12" spread without lens on trim.

3" ARCHITECTURAL SQUARE FLANGE DOWNLIGHT COMPATIBLE WITH 6" TECHZONE® CEILINGS
(SILHOUETTE®, SUPRAFINE®, INTERLUDE®, OR PRELUDE®) BY ARMSTRONG®

PERFORMANCE CHART

| Optics | | ¹ 12° | 25° | 30° | 40° | 50° | 70° |
|------------|------------------|------------------|------|------|------|------|------|
| 6W | Initial Lumens | 657 | 955 | 955 | 955 | 955 | 955 |
| | Delivered Lumens | 586 | 718 | 755 | 754 | 726 | 602 |
| | UGR | | 13.5 | 13 | 16.4 | 19.1 | 21 |
| 9W | Initial Lumens | 890 | 1296 | 1296 | 1296 | 1296 | 1296 |
| | Delivered Lumens | 794 | 978 | 1034 | 1038 | 984 | 825 |
| | UGR | | 14.6 | 14.3 | 17.7 | 19.6 | 22.3 |
| 12W | Initial Lumens | 1122 | 1618 | 1618 | 1618 | 1618 | 1618 |
| | Delivered Lumens | 999 | 1225 | 1314 | 1319 | 1238 | 1051 |
| | UGR | | 15.2 | 15.1 | 18.3 | 21.2 | 22.9 |
| 15W | Initial Lumens | 1267 | 2015 | 2015 | 2015 | 2015 | 2015 |
| | Delivered Lumens | 1060 | 1470 | 1628 | 1642 | 1565 | 1227 |
| | UGR | | 15.9 | 15.8 | 19 | 21.9 | 23.6 |
| 20W | Initial Lumens | 1485 | 2422 | 2422 | 2422 | 2422 | 2422 |
| | Delivered Lumens | 1244 | 1778 | 1967 | 1985 | 1895 | 1482 |
| | UGR | | 16.6 | 16.4 | 19.7 | 22.5 | 24.3 |
| 24W | Initial Lumens | | 2799 | 2799 | 2799 | 2799 | 2799 |
| | Delivered Lumens | | 2107 | 2273 | 2296 | 2193 | 1713 |
| | UGR | | 17.4 | 17 | 20.2 | 23.1 | 24.8 |
| 28W | Initial Lumens | | 3128 | 3128 | 3128 | 3128 | 3128 |
| | Delivered Lumens | | 2343 | 2542 | 2569 | 2458 | 1914 |
| | UGR | | 17.7 | 17.3 | 20.6 | 23.6 | 25.2 |
| 32W | Initial Lumens | | 3405 | 3405 | 3405 | 3405 | 3405 |
| | Delivered Lumens | | 2544 | 2768 | 2785 | 2679 | 2080 |
| | UGR | | 18 | 17.7 | 20.9 | 23.9 | 25.4 |

* Values are listed at 3000K, 90+ CRI with a white bevel & trim.

Notes

1. 12° spread without lens on trim

COLOR TEMPERATURE MULTIPLIER FOR DELIVERED LUMENS

| 2700K | 3000K | 3500K | 4000K |
|-------|-------|-------|-------|
| 0.95 | 1.00 | 1.04 | 1.07 |

3SFO-CS REGRESS SMALL OPENING

3SFO-CL REGRESS LARGE OPENING

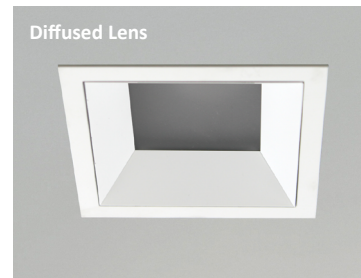
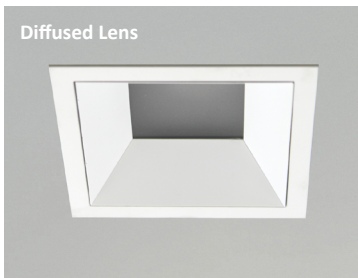

- IES files are based on the large opening trim with diffused lens.

- Not suitable for wet locations
- Increase in lumens by approximately 7%

- IES files are based on the large opening trim with diffused lens.

- Not suitable for wet locations
- Increase in lumens by approximately 7%

3" ARCHITECTURAL SQUARE FLANGE DOWNLIGHT COMPATIBLE WITH 6" TECHZONE® CEILINGS (SILHOUETTE®, SUPRAFINE®, INTERLUDE®, OR PRELUDE®) BY ARMSTRONG®

HOUSING DIMENSIONS

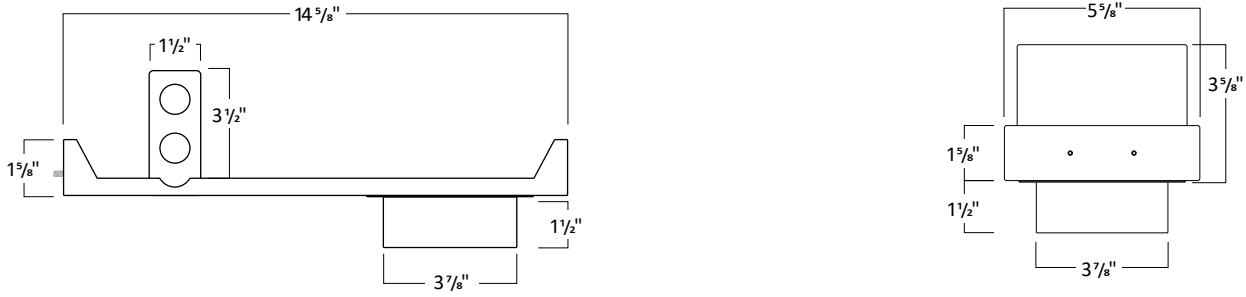

FRAME ACCESSORIES

UNIVERSAL BAR HANGER

COMPATIBLE CEILING

- Hat Channel
- T-Bar
- C-Channel
- Laminated Wood
- Quick-Span
- I-Beam
- Standard Joist

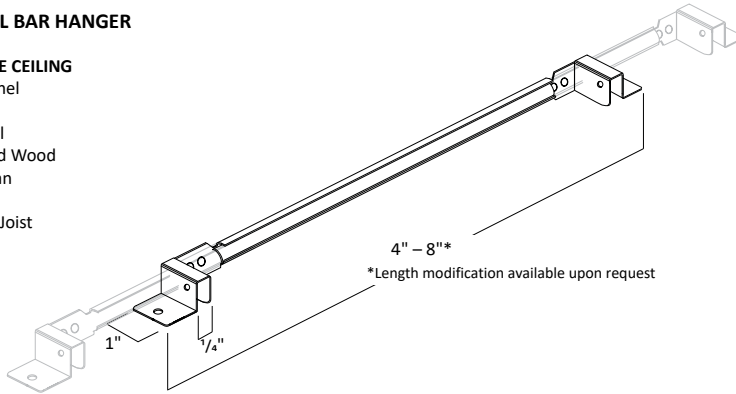

MODULE DIMENSIONS

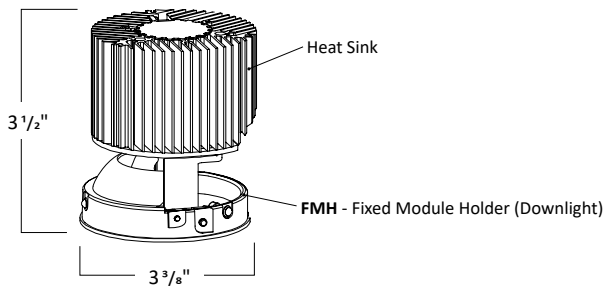

3" ARCHITECTURAL SQUARE FLANGE DOWNLIGHT COMPATIBLE WITH 6" TECHZONE® CEILINGS
(SILHOUETTE®, SUPRAFINE®, INTERLUDE®, OR PRELUDE®) BY ARMSTRONG®

FILTERS

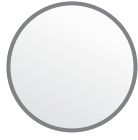

Frosted Filter

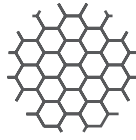

Honey Comb

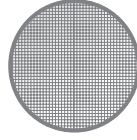

Solite Filter



Linear Filter

TRIM DIMENSIONS

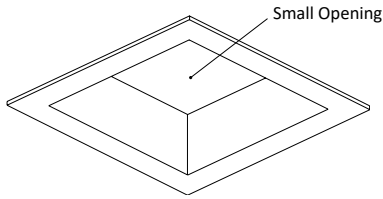

3SFO-CS

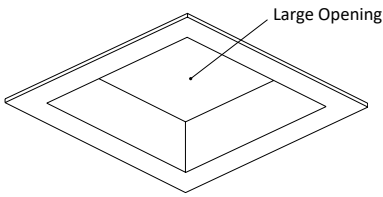
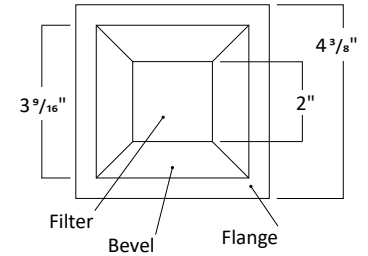
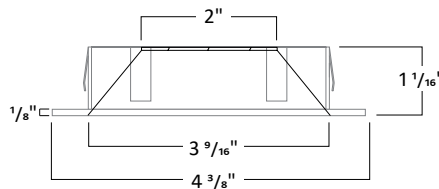

3SFO-CL

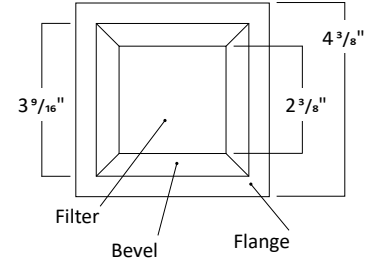
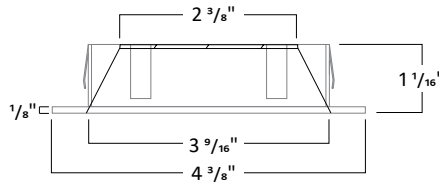

TRIM FINISH

May be mixed and matched



White



Black



Haze



Bronze



Clear

*Consult Factory for Made to Order Finishes