

3" ARCHITECTURAL ROUND FLANGE DOWNLIGHT COMPATIBLE WITH 6" TECHZONE® CEILINGS (SILHOUETTE®, SUPRAFINE®, INTERLUDE®, OR PRELUDE®) BY ARMSTRONG®



USE OF PRODUCT

The 3" Prime Downlight is a small aperture fixture which is compatible with 6" TechZone® ceilings. Allows for seamless installation and integration of luminaires with Silhouette®, Suprafine®, Interlude®, or Prelude® ceiling types offered by Armstrong®. Available options include die-cast trims, various temperatures, optics, and dimmable drivers.

LED ENGINE

LED engine available with CREE LEDs in 2700K, 3000K, 3500K, or 4000K in standard 90+ CRI. 2-step MacAdam ellipse allows for color consistency between fixtures. The LED is mounted to an aluminum heat sink for maximum life output and thermal management. LED engine is accessible from below the ceiling.

FRAME CONSTRUCTION

Non IC housing constructed from 20-gauge cold-rolled steel and includes a junction box with ½" knockouts. Integrated mounting brackets that will snap directly into 6" TechZone® ceiling grids. Compatible with the following series: Silhouette®, Suprafine®, Interlude®, or Prelude®.

GENERAL PERFORMANCE CHART

*Detailed performance chart may be found on page 3

| | 6W | 9W | 12W | 15W | 20W | 24W | 28W | 32W |
|-------------------------|---------|----------|-----------|-----------|-----------|-----------|-----------|-----------|
| Initial Lumens | 657/955 | 890/1296 | 1122/1618 | 1267/2015 | 1485/2422 | 2799 | 3128 | 3405 |
| Delivered Lumens | 586-755 | 794-1038 | 999-1319 | 1060-1642 | 1244-1985 | 1713-2296 | 1914-2569 | 2080-2785 |

* Values are listed at 3000K, 90+ CRI with a white bevel & trim.
Delivered lumens range based on beam spread.
Performance may vary +/- 5%

OPTICAL LENS

Field replaceable optical lenses are available in 12°, 25°, 30°, 40°, 50°, and 70°. Easily achieve narrow spot to wide flood beam pattern.

DIMMING

Available in six driver selections. (ID) Standard all-inclusive ELV (120V), Triac (120V), and 0-10V (120-277V) dimming driver called Intelligent Drive, 120-277V. (LDE1) Lutron Hi-Lume 1% Ecosystem with soft-on, fade-to-black dimming, 120-277V. (L3DA) Hi-lume 1% EcoSystem/3-Wire L3D Driver (EEI) eidoLED Eco 1% Dim (0-10V), 120-277V. (EDIO) eidoLED Solo 0.1% Dim (0-10V), 120-277V. (EDID) eidoLED Solo 0.1% Dim (DALI), 120-277V. Driver accessible from below ceiling.

THERMAL MANAGEMENT

Fixture location ambient temperature should not exceed -20° to 40°C.

TRIM

Die-cast trim. Consult factory for made-to-order finishes.

EMERGENCY BATTERY

Optional emergency battery available for a minimum of 90 minutes with remote test switch in 800 delivered lumens.

LABELS/COMPLIANCE/WARRANTY

- CSA Listed for US and Canada.
- Energy Star certified product.
- Dry/Damp location rated.
- 5-year limited warranty.



BEAM SPREAD

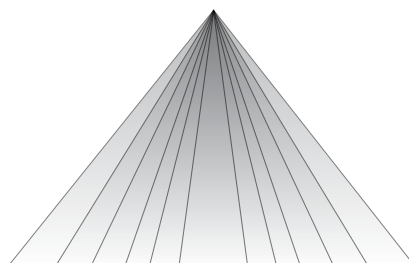

Available optics: 12° 25° 30° 40° 50° 70°

- Field replaceable TIR optics
- Easily achieve narrow spot to wide flood beam pattern
- Optional filters available upon request

PRIME FAMILY OF PRODUCTS



Downlight



TechZone®



WoodWorks®



Multiple Dedicated Bevel



Multiple Open Bevel



Cylinder

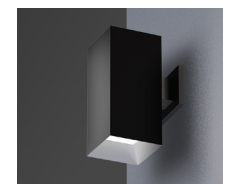

Square Luminaire

3" ARCHITECTURAL ROUND FLANGE DOWNLIGHT COMPATIBLE WITH 6" TECHZONE® CEILINGS (SILHOUETTE®, SUPRAFINE®, INTERLUDE®, OR PRELUDE®) BY ARMSTRONG®

ORDERING INFORMATION

| Series | Wattage | Dimming | Color Temperature | Optical Lens | Filter |
|--------|--|---|--|---|--|
| RPA3 | 6W - 6 Watt 9W - 9 Watt 12W - 12 Watt 15W - 15 Watt 20W - 20 Watt 24W - 24 Watt 28W - 28 Watt 32W - 32 Watt | ID ¹ - Standard All-Inclusive ELV, Triac, and 0-10V Dimming Driver (Intelligent Drive) LDE1 ² - Lutron Hi-Lume 1% Ecosystem with Soft-on, Fade-to-Black Dimming L3DA - Hi-lume 1% EcoSystem/3-Wire L3D Driver EEI ³ - eldoLED Eco 1% Dim (0-10V) EDI ³ - eldoLED Solo 0.1% Dim (0-10V) EDI ³ - eldoLED Solo 0.1% Dim (DALI) | 27 - 2700K 30 - 3000K 35 - 3500K 40 - 4000K | 12 ⁴ - 12° 25 - 25° 30 - 30° 40 - 40° 50 - 50° 70 - 70° | None - Leave Blank F - Frosted Filter H - Honey Comb S - Solite Filter L - Linear Filter |

| Housing Type | Collar | Module Type | Frame Accessories | Options |
|----------------------------|---|-----------------|---------------------------|---|
| TZ6 - 6" TechZone® Ceiling | CR10 - 1.0" Depth CR15 - 1.5" Depth MTO - Made To Order | FMH - Downlight | UH - Universal Bar Hanger | ER8W - Emergency Battery with Remote test switch (800 lm) ER15W - Emergency Battery with Remote test switch (1,500 lm) |

TRIM ORDERING INFORMATION

DIE-CAST

| Bevel / Flange Finish | Trim Type | Bevel | Flange |
|--------------------------|---------------------------------------|---------|---------------------|
| May be mixed and matched | 3" Round Flange Regress Small Opening | 3RFO-CS | W - White |
| | | 3RFO-CS | B - Black |
| | | 3RFO-CS | H - Haze |
| | | 3RFO-CS | BZ - Bronze |
| | | 3RFO-CS | MTO - Made To Order |
| | 3" Round Flange Regress Large Opening | 3RFO-CL | W - White |
| | | 3RFO-CL | B - Black |
| | | 3RFO-CL | H - Haze |
| | | 3RFO-CL | BZ - Bronze |
| | | 3RFO-CL | MTO - Made To Order |

- Notes**
- Intelligent Drive is the standard driver.
 - Not offered in 6W.
 - Must specify logarithmic or linear eldoLED diver.
 - 12° spread without lens on trim.

SPUN ALUMINUM (SELF-FLANGED)

| Bevel / Flange Finish | Trim Type | Self-Flanged |
|---------------------------------------|-----------|---------------------|
| 3" Round Flange Regress Small Opening | 3RFO-AS | H - Haze |
| | 3RFO-AS | C - Clear |
| | 3RFO-AS | MTO - Made To Order |
| 3" Round Flange Regress Large Opening | 3RFO-AL | H - Haze |
| | 3RFO-AL | C - Clear |
| | 3RFO-AL | MTO - Made To Order |

3" ARCHITECTURAL ROUND FLANGE DOWNLIGHT COMPATIBLE WITH 6" TECHZONE® CEILINGS (SILHOUETTE®, SUPRAFINE®, INTERLUDE®, OR PRELUDE®) BY ARMSTRONG®

PERFORMANCE CHART

| Optics | | ¹ 12° | 25° | 30° | 40° | 50° | 70° |
|------------|------------------|------------------|------|------|------|------|------|
| 6W | Initial Lumens | 657 | 955 | 955 | 955 | 955 | 955 |
| | Delivered Lumens | 586 | 718 | 755 | 754 | 726 | 602 |
| | UGR | | 13.5 | 13 | 16.4 | 19.1 | 21 |
| 9W | Initial Lumens | 890 | 1296 | 1296 | 1296 | 1296 | 1296 |
| | Delivered Lumens | 794 | 978 | 1034 | 1038 | 984 | 825 |
| | UGR | | 14.6 | 14.3 | 17.7 | 19.6 | 22.3 |
| 12W | Initial Lumens | 1122 | 1618 | 1618 | 1618 | 1618 | 1618 |
| | Delivered Lumens | 999 | 1225 | 1314 | 1319 | 1238 | 1051 |
| | UGR | | 15.2 | 15.1 | 18.3 | 21.2 | 22.9 |
| 15W | Initial Lumens | 1267 | 2015 | 2015 | 2015 | 2015 | 2015 |
| | Delivered Lumens | 1060 | 1470 | 1628 | 1642 | 1565 | 1227 |
| | UGR | | 15.9 | 15.8 | 19 | 21.9 | 23.6 |
| 20W | Initial Lumens | 1485 | 2422 | 2422 | 2422 | 2422 | 2422 |
| | Delivered Lumens | 1244 | 1778 | 1967 | 1985 | 1895 | 1482 |
| | UGR | | 16.6 | 16.4 | 19.7 | 22.5 | 24.3 |
| 24W | Initial Lumens | | 2799 | 2799 | 2799 | 2799 | 2799 |
| | Delivered Lumens | | 2107 | 2273 | 2296 | 2193 | 1713 |
| | UGR | | 17.4 | 17 | 20.2 | 23.1 | 24.8 |
| 28W | Initial Lumens | | 3128 | 3128 | 3128 | 3128 | 3128 |
| | Delivered Lumens | | 2343 | 2542 | 2569 | 2458 | 1914 |
| | UGR | | 17.7 | 17.3 | 20.6 | 23.6 | 25.2 |
| 32W | Initial Lumens | | 3405 | 3405 | 3405 | 3405 | 3405 |
| | Delivered Lumens | | 2544 | 2768 | 2785 | 2679 | 2080 |
| | UGR | | 18 | 17.7 | 20.9 | 23.9 | 25.4 |

* Values are listed at 3000K, 90+ CRI with a white bevel & trim.

Notes

1. 12° spread without lens on trim

COLOR TEMPERATURE MULTIPLIER FOR DELIVERED LUMENS

| 2700K | 3000K | 3500K | 4000K |
|-------|-------|-------|-------|
| 0.95 | 1.00 | 1.04 | 1.07 |

3RFO-CS REGRESS SMALL OPENING

3RFO-CL REGRESS LARGE OPENING



- IES files are based on the large opening trim with diffused lens.

- Not suitable for wet locations
- Increase in lumens by approximately 7%

- IES files are based on the large opening trim with diffused lens.

- Not suitable for wet locations
- Increase in lumens by approximately 7%

3" ARCHITECTURAL ROUND FLANGE DOWNLIGHT COMPATIBLE WITH 6" TECHZONE® CEILINGS (SILHOUETTE®, SUPRAFINE®, INTERLUDE®, OR PRELUDE®) BY ARMSTRONG®

HOUSING DIMENSIONS

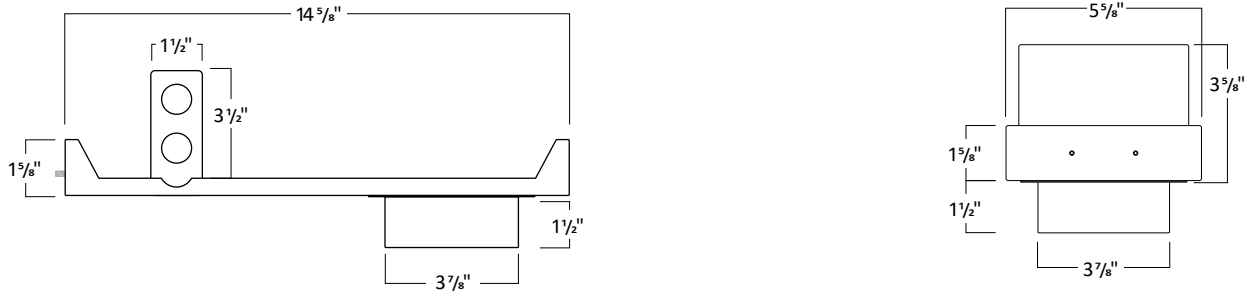

FRAME ACCESSORIES

UNIVERSAL BAR HANGER

COMPATIBLE CEILING

- Hat Channel
- T-Bar
- C-Channel
- Laminated Wood
- Quick-Span
- I-Beam
- Standard Joist

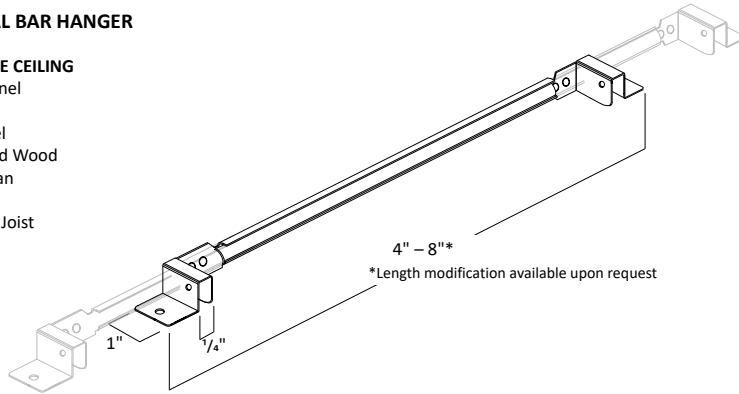

MODULE DIMENSIONS

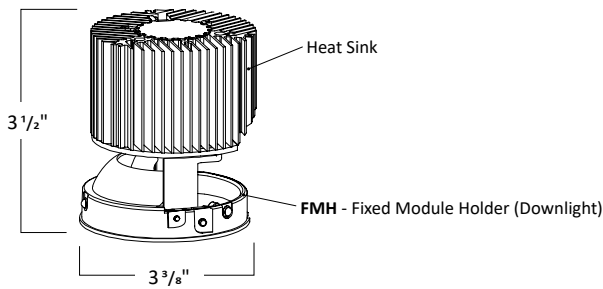

3" ARCHITECTURAL ROUND FLANGE DOWNLIGHT COMPATIBLE WITH 6" TECHZONE® CEILINGS
(SILHOUETTE®, SUPRAFINE®, INTERLUDE®, OR PRELUDE®) BY ARMSTRONG®

FILTERS

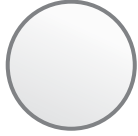

Frosted Filter



Honey Comb

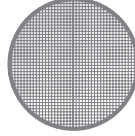

Solite Filter



Linear Filter

TRIM DIMENSIONS

DIE-CAST

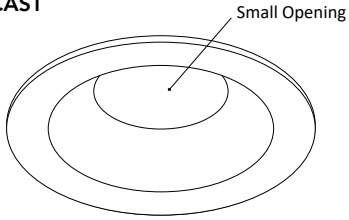

3RFO-CS

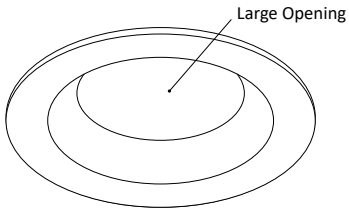
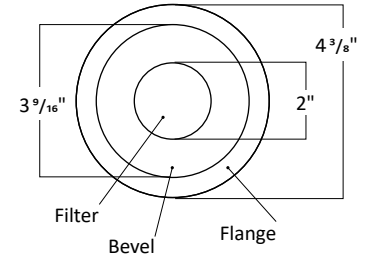
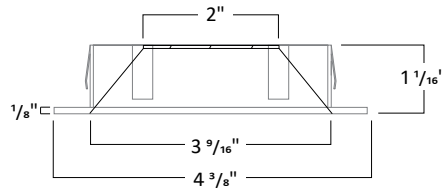

3RFO-CL

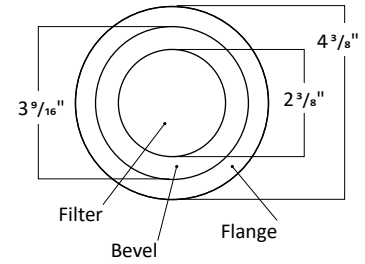
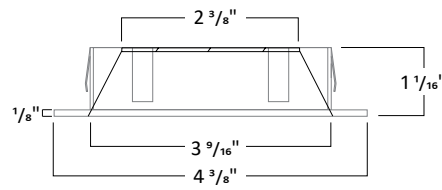

TRIM FINISH

May be mixed and matched



*Consult Factory for Made to Order Finishes