

3" ARCHITECTURAL ROUND FLANGE ADJUSTABLE COMPATIBLE WITH 6" TECHZONE® CEILINGS (SILHOUETTE®, SUPRAFINE®, INTERLUDE®, OR PRELUDE®) BY ARMSTRONG®



USE OF PRODUCT

The 3" Prime series is a small aperture fixture which is compatible with 6" TechZone® ceilings. Allows for seamless installation and integration of luminaires with Silhouette®, Suprafine®, Interlude®, or Prelude® ceiling types offered by Armstrong®. Available options include die-cast trims, various temperatures, optics, and dimmable drivers.

LED ENGINE

LED engine available with CREE LEDs in 2700K, 3000K, 3500K, or 4000K in standard 90+ CRI. 2-step MacAdam ellipse allows for color consistency between fixtures. The LED is mounted to an aluminum heat sink for maximum life output and thermal management. LED engine is accessible from below the ceiling.

FRAME CONSTRUCTION

Non IC housing constructed from 20-gauge cold-rolled steel and includes a junction box with ½" knockouts. Integrated mounting brackets that will snap directly into 6" TechZone® ceiling grids. Compatible with the following series: Silhouette®, Suprafine®, Interlude®, or Prelude®.

OPTICAL LENS

Field replaceable optical lenses are available in 12°, 30°, 35°, 40°, 50°, and 60°. Easily achieve narrow spot to wide flood beam pattern.

DIMMING

Available in six driver selections. (ID) Standard all-inclusive ELV (120V), Triac (120V), and 0–10V (120–277V) dimming driver called Intelligent Drive, 120–277V. (LDE1) Lutron Hi-Lume 1% Ecosystem with soft-on, fade-to-black dimming, 120–277V. (L3DA) Hi-lume 1% EcoSystem/3-Wire L3D Driver (EEI) eldoLED Eco 1% Dim (0–10V), 120–277V. (EDIO) eldoLED Solo 0.1% Dim (0–10V), 120–277V. (EDID) eldoLED Solo 0.1% Dim (DALI), 120–277V. Driver accessible from below ceiling.

THERMAL MANAGEMENT

Fixture location ambient temperature should not exceed -20° to 40°C.

TRIM

Die-cast trim. Consult factory for made-to-order finishes.

EMERGENCY BATTERY

Optional emergency battery available for a minimum of 90 minutes with remote test switch in 800 delivered lumens.

LABELS/COMPLIANCE/WARRANTY

- CSA Listed for US and Canada.
- Energy Star certified product.
- Dry/Damp location rated.
- 5-year limited warranty.



GENERAL PERFORMANCE CHART

*Detailed performance chart may be found on page 3

	6W	9W	12W	15W	20W	24W	28W	32W
Initial Lumens	657/955	890/1296	1122/1618	1267/2015	1485/2422	2799	3128	3405
Delivered Lumens	436-720	598-986	758-1255	947-1558	1113-1912	1284-2202	1437-2455	1566-2776

* Values are listed at 3000K, 90+ CRI with a white bevel & trim. Delivered lumens range based on beam spread. Performance may vary +/- 5%

BEAM SPREAD

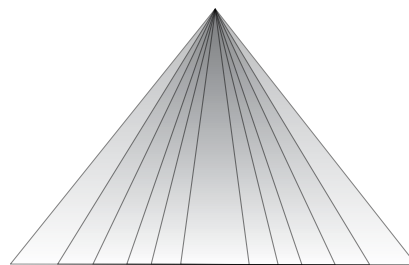

Available optics: 12° 30° 35° 40° 50° 60°

- Field replaceable TIR optics
- Easily achieve narrow spot to wide flood beam pattern
- Optional filters available upon request

PRIME FAMILY OF PRODUCTS

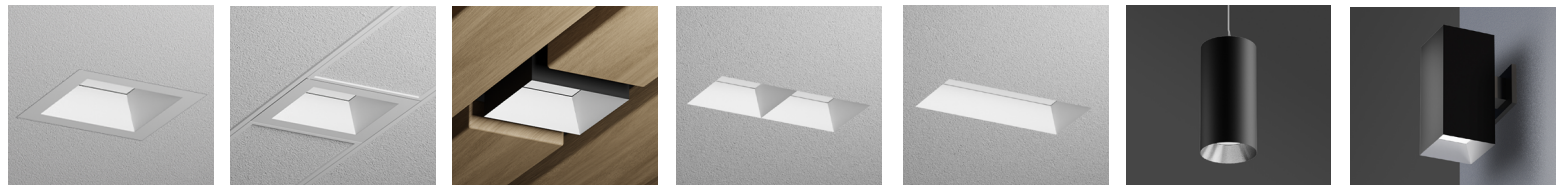

Downlight TechZone® WoodWorks® Multiple Dedicated Bevel Multiple Open Bevel Cylinder Square Luminaire

3" ARCHITECTURAL ROUND FLANGE ADJUSTABLE COMPATIBLE WITH 6" TECHZONE® CEILINGS (SILHOUETTE®, SUPRAFINE®, INTERLUDE®, OR PRELUDE®) BY ARMSTRONG®

ORDERING INFORMATION

Series	Wattage	Dimming	Color Temperature	Optical Lens	Filter
RPA3	6W - 6 Watt	ID ¹ - Standard All-Inclusive ELV, Triac, and 0-10V Dimming Driver (Intelligent Drive)	27 - 2700K	12 ⁴ - 12°	None - Leave Blank
	9W - 9 Watt		30 - 3000K	30 - 30°	F - Frosted Filter
	12W - 12 Watt	EEI ² - eldoLED 1% Dim (0-10V)	35 - 3500K	35 - 35°	H - Honey Comb
	15W - 15 Watt	EEI ³ - eldoLED 1% Dim 0-10V (120-277V), Triac (120V), Max 20W	40 - 4000K	40 - 40°	S - Solite Filter
	20W - 20 Watt		50 - 50°	L - Linear Filter	
	24W - 24 Watt	EDIO ² - eldoLED 0.1% Dim (0-10V)		60 - 60°	
	28W - 28 Watt	EDID ² - eldoLED 0.1% Dim (DALI)			
	32W - 32 Watt	EDD ² - eldoLED 1% Dim (DALI2)			
		LDE1 ⁴ - Lutron Hi-Lume 1% Ecosystem with Soft-on, Fade-to-Black Dimming			
		L3DA ⁴ - Hi-Lume 1% Ecosystem/3-Wire L3D Driver			
	PEQ0 - Lutron Hi-Lume Premier Ecosystem 0.1% with Soft-on, Fade-to-Black Dimming				

Housing Type	Collar	Module Type	Frame Accessories	Options
TZ6 - 6" TechZone® Ceiling	CR10 - 1.0" Depth CR15 - 1.5" Depth MTO - Made To Order	AMH - Adjustable	UH - Universal Bar Hanger	ER8W - Emergency Battery with Remote test switch (800 lm) ER15W - Emergency Battery with Remote test switch (1,500 lm)

TRIM ORDERING INFORMATION

DIE-CAST

Bevel / Flange Finish	Trim Type	Bevel	Flange
May be mixed and matched	3" Round Flange Regress Large Opening	3RFO-CL	W - White
		3RFO-CL	B - Black
		3RFO-CL	H - Haze
		3RFO-CL	BZ - Bronze
		3RFO-CL	MTO - Made To Order
	3" Round Flange Accent	3RFA-CL	W - White
		3RFA-CL	B - Black
		3RFA-CL	H - Haze
		3RFA-CL	BZ - Bronze
		3RFA-CL	MTO - Made To Order

Notes

1. Intelligent Drive is the standard driver.
2. Must specify logarithmic or linear eldoLED driver.
3. Driver available up to 20W and programmed only in linear mode.
4. Not offered in 6W.
5. 12" spread without lens on trim.

SPUN ALUMINUM (SELF-FLANGED)

Bevel / Flange Finish	Trim Type	Self-Flanged
3" Round Flange Regress Large Opening	3RFO-AL	H - Haze
	3RFO-AL	C - Clear
	3RFO-AL	MTO - Made To Order
3" Round Flange Accent	3RFA-AL	H - Haze
	3RFA-AL	C - Clear
	3RFA-AL	MTO - Made To Order

3" ARCHITECTURAL ROUND FLANGE ADJUSTABLE COMPATIBLE WITH 6" TECHZONE® CEILINGS (SILHOUETTE®, SUPRAFINE®, INTERLUDE®, OR PRELUDE®) BY ARMSTRONG®

PERFORMANCE CHART

Optics		¹ 12°	30°	35°	40°	50°	60°
6W	Initial Lumens	657	955	955	955	955	955
	Delivered Lumens	555	645	720	717	658	436
	UGR		11.8	12	15.1	18.1	19.1
9W	Initial Lumens	890	1296	1296	1296	1296	1296
	Delivered Lumens	750	883	986	986	900	598
	UGR		13.1	13.3	16.5	19.6	20.5
12W	Initial Lumens	1122	1618	1618	1618	1618	1618
	Delivered Lumens	941	1120	1248	1255	1140	758
	UGR		13.6	13.9	17.1	20.1	21.2
15W	Initial Lumens	1267	2015	2015	2015	2015	2015
	Delivered Lumens	1007	1375	1558	1558	1493	947
	UGR		14.4	14.6	17.8	20.8	22.7
20W	Initial Lumens	1485	2422	2422	2422	2422	2422
	Delivered Lumens	1187	1689	1912	1887	1803	1113
	UGR		15.1	15.4	18.5	21.5	22.5
24W	Initial Lumens		2799	2799	2799	2799	2799
	Delivered Lumens		1947	2202	2185	2083	1284
	UGR		15.6	15.9	19	22	23
28W	Initial Lumens		3128	3128	3128	3128	3128
	Delivered Lumens		2173	2455	2446	2328	1437
	UGR		16	16.3	19.4	22.4	23.4
32W	Initial Lumens		3405	3405	3405	3405	3405
	Delivered Lumens		2362	2776	2666	2533	1566
	UGR		17.8	17	19.7	22.6	23.7

* Values are listed at 3000K, 90+ CRI with a white bevel & trim.

Notes

1. 12° spread without lens on trim

COLOR TEMPERATURE MULTIPLIER FOR DELIVERED LUMENS

2700K	3000K	3500K	4000K
0.95	1.00	1.04	1.07

3RFO-CL REGRESS LARGE OPENING

3RFA-CL ACCENT



- IES files are based on the open trim with diffused lens.

- Not suitable for wet locations
- Increase in lumens by approximately 7%

- IES files are based on the open trim with diffused lens.

- Not suitable for wet locations
- Increase in lumens by approximately 7%

3" ARCHITECTURAL ROUND FLANGE ADJUSTABLE COMPATIBLE WITH 6" TECHZONE® CEILINGS (SILHOUETTE®, SUPRAFINE®, INTERLUDE®, OR PRELUDE®) BY ARMSTRONG®

HOUSING DIMENSIONS

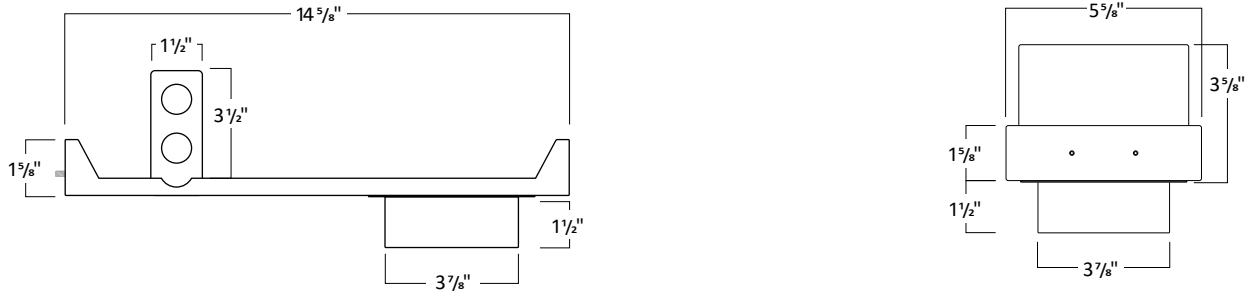

FRAME ACCESSORIES

UNIVERSAL BAR HANGER

COMPATIBLE CEILING

- Hat Channel
- T-Bar
- C-Channel
- Laminated Wood
- Quick-Span
- I-Beam
- Standard Joist

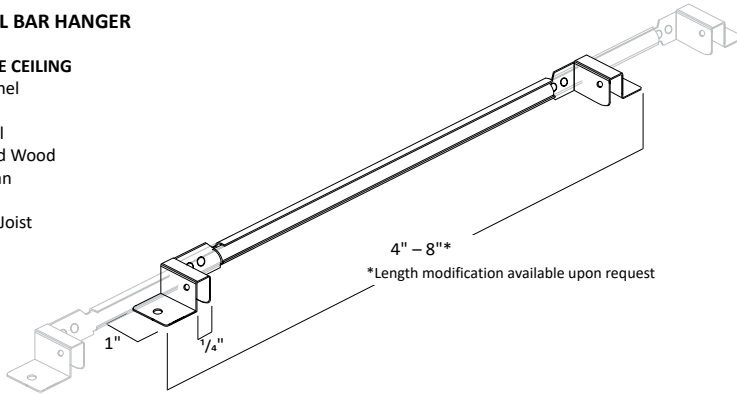

LED MODULE

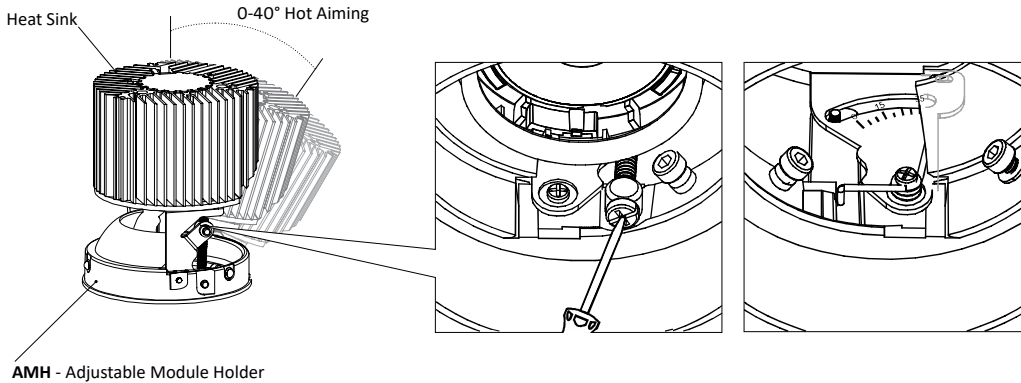

FILTERS

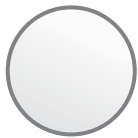

Frosted Filter

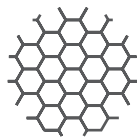

Honey Comb

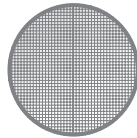

Solite Filter



Linear Filter

3" ARCHITECTURAL ROUND FLANGE ADJUSTABLE COMPATIBLE WITH 6" TECHZONE® CEILINGS
(SILHOUETTE®, SUPRAFINE®, INTERLUDE®, OR PRELUDE®) BY ARMSTRONG®

TRIM DIMENSIONS

DIE-CAST

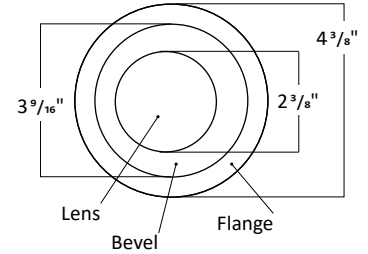
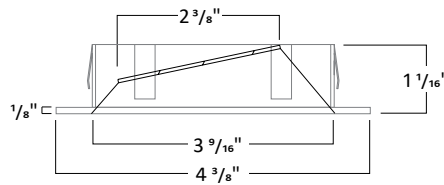
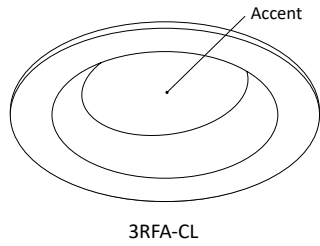
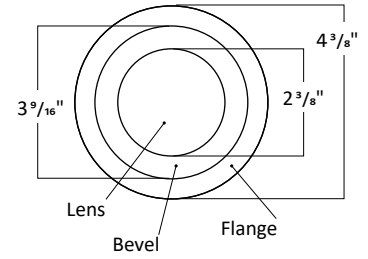
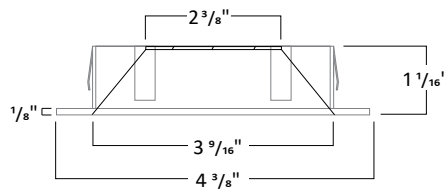
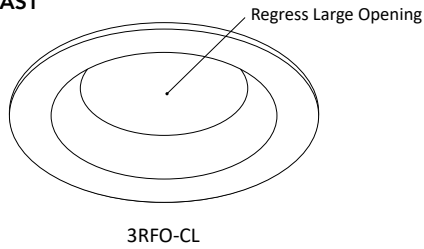

TRIM FINISH

May be mixed and matched



*Consult Factory for Made to Order Finishes

SPUN ALUMINUM (SELF-FLANGED)

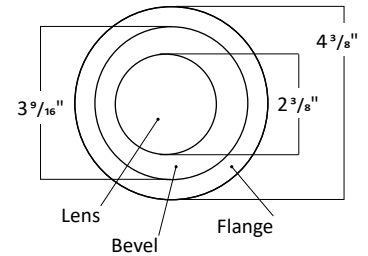
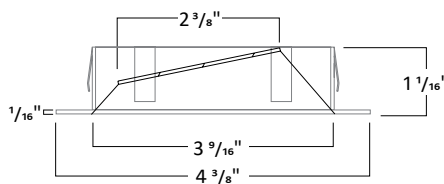
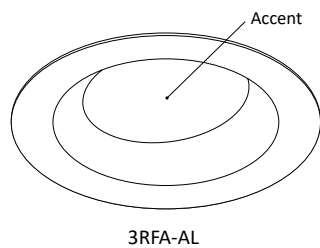
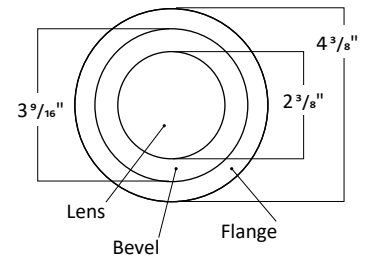
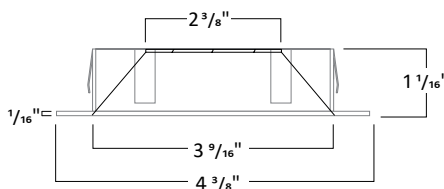
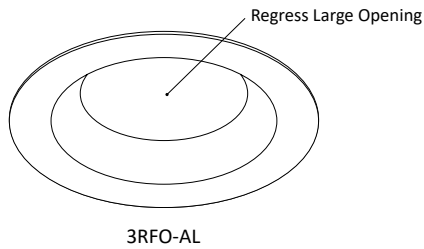

TRIM FINISH



*Consult Factory for Made to Order Finishes